



• Rev. 01

Latest version of this manual

# Ditec

IP2246EN • 2025/09/01

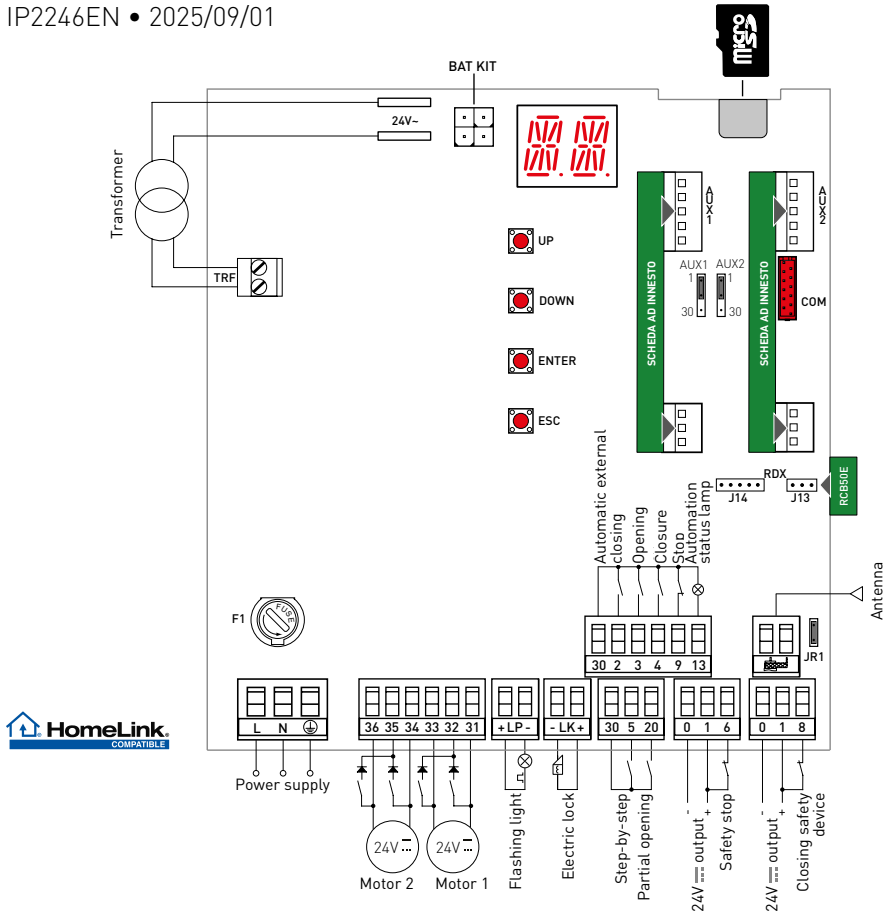

## Ditec LCU40H

Control panel installation manual for automations with one or two 24V AC motors  
(Translation of the original instructions)

# INDEX

|            |                                                                                                            |           |
|------------|------------------------------------------------------------------------------------------------------------|-----------|
| <b>1.</b>  | <b>General safety precautions</b> .....                                                                    | <b>3</b>  |
| 1.1        | Safety functions .....                                                                                     | 4         |
| <b>2.</b>  | <b>EC Declaration of Conformity</b> .....                                                                  | <b>4</b>  |
| <b>3.</b>  | <b>Technical specifications</b> .....                                                                      | <b>4</b>  |
| 3.1        | Applications .....                                                                                         | 5         |
| <b>4.</b>  | <b>Installation and electrical connections</b> .....                                                       | <b>5</b>  |
| 4.1        | Maintenance .....                                                                                          | 7         |
| 4.2        | Standard installation .....                                                                                | 7         |
| 4.3        | Standard installation diagram .....                                                                        | 8         |
| <b>5.</b>  | <b>Programming</b> .....                                                                                   | <b>9</b>  |
| 5.1        | Switching the display ON and OFF.....                                                                      | 9         |
| 5.2        | Navigation keys.....                                                                                       | 9         |
| 5.3        | Menu map .....                                                                                             | 10        |
| <b>6.</b>  | <b>Quick start-up sequences</b> .....                                                                      | <b>12</b> |
| 6.1        | Selection of automation type.....                                                                          | 12        |
| 6.2        | Configuration of the number of gate wings.....                                                             | 12        |
| 6.3        | Enabling the configurations .....                                                                          | 12        |
| 6.4        | Adding remote controls.....                                                                                | 12        |
| 6.5        | Configuration of the limit switches.....                                                                   | 13        |
| 6.6        | Configuration of the safety devices.....                                                                   | 13        |
| <b>7.</b>  | <b>Application examples</b> .....                                                                          | <b>14</b> |
| 7.1        | Automations with two swinging gates .....                                                                  | 14        |
| 7.2        | Automations with one swinging gate wing .....                                                              | 14        |
| 7.3        | Up-and-over doors with two parallel motors.....                                                            | 15        |
| <b>8.</b>  | <b>Commands</b> .....                                                                                      | <b>16</b> |
| 8.1        | Inserting plug-in boards (AUX).....                                                                        | 17        |
| 8.2        | SOFA1-SOFA2 or GOPAVRS self-controlled safety edge .....                                                   | 17        |
| <b>9.</b>  | <b>Outputs and accessories</b> .....                                                                       | <b>18</b> |
| <b>10.</b> | <b>Jumper setting</b> .....                                                                                | <b>19</b> |
| <b>11.</b> | <b>Adjustments</b> .....                                                                                   | <b>20</b> |
| 11.1       | Main menu .....                                                                                            | 20        |
| 11.2       | Second level menu - AT (Automatic Configurations) .....                                                    | 21        |
| 11.2.1     | Selection of automation type <b>AT</b> → <b>AS</b> and specific default settings .....                     | 22        |
| 11.3       | Second level menu - BC (Basic Configurations).....                                                         | 23        |
| 11.3.1     | Additional BC level parameters that can be configured (available with <b>AT</b> → <b>AA</b> enabled) ..... | 23        |
| 11.4       | Second level menu - BA (Basic Adjustment).....                                                             | 24        |
| 11.4.1     | Additional BA level parameters that can be configured (available with <b>AT</b> → <b>AA</b> enabled).....  | 26        |
| 11.5       | Second level menu - RO (Radio Operations) .....                                                            | 28        |
| 11.5.1     | Additional RO level parameters that can be configured (available with <b>AT</b> → <b>AA</b> enabled) ..... | 29        |
| 11.6       | Second level menu - SF (Special Functions).....                                                            | 30        |
| 11.6.1     | Additional SF level parameters that can be configured (available with <b>AT</b> → <b>AA</b> enabled) ..... | 31        |
| 11.7       | Second level menu - CC (Cycles Counter).....                                                               | 32        |
| 11.7.1     | Additional CC level parameters that can be configured (available with <b>AT</b> → <b>AA</b> enabled) ..... | 33        |
| 11.8       | Second level menu - EM (Energy Management) .....                                                           | 33        |
| 11.8.1     | Additional EM level parameters that can be configured (available with <b>AT</b> → <b>AA</b> enabled).....  | 34        |
| 11.9       | Second level menu - AP (Advanced Parameters).....                                                          | 34        |
| 11.9.1     | Additional AP level parameters that can be configured (available with <b>AT</b> → <b>AA</b> enabled) ..... | 36        |
| <b>12.</b> | <b>Diagnostics</b> .....                                                                                   | <b>38</b> |
| 12.1       | Data Logging integrated in the board.....                                                                  | 38        |
| 12.1.1     | Alarm counter.....                                                                                         | 38        |
| 12.1.2     | Alarm log .....                                                                                            | 38        |
| 12.1.3     | Exporting information on the microSD .....                                                                 | 39        |
| 12.2       | Extended data logging on microSD .....                                                                     | 39        |

|      |                                             |    |
|------|---------------------------------------------|----|
| 13.  | Signals visualised on the display .....     | 40 |
| 13.1 | Display of automation status .....          | 40 |
| 13.2 | Display of safety devices and commands..... | 40 |
| 13.3 | Visualisation of alarms and faults .....    | 42 |
| 14.  | Troubleshooting.....                        | 45 |



This symbol indicates instructions or notes regarding safety, to which special attention must be paid.



This symbol indicates useful information for the correct functioning of the product.



Factory settings

# 1. General safety precautions



Failure to observe the information given in this manual may lead to personal injury or damage to the equipment. Keep these instructions for future reference

This installation manual is intended for qualified personnel only • Installation, electrical connections and adjustments must be performed in accordance with Good Working Methods and in compliance with the present standards • This product must only be used for the specific purpose for which it was designed • Any other use is to be considered improper and therefore dangerous. The manufacturer cannot be held responsible for any damage caused by improper, incorrect or unreasonable use • Read the instructions carefully before installing the product.



Incorrect installation could be dangerous • The packaging materials (plastic, polystyrene, etc.) should not be discarded in the environment or left within reach of children, as they are a potential source of danger • Before installing the product, make sure it is in perfect condition • Do not install the product in explosive areas and atmospheres: the presence of inflammable gas or fumes represents a serious safety hazard • The safety devices (photocells, safety edges, emergency stops, etc.) must be installed taking into account the applicable laws and directives, Good Working Methods, installation premises, system operating logic and the forces developed



by the automation • Before connecting the power supply, make sure the plate data correspond to those of the mains power supply. An omnipolar disconnection switch with a contact opening distance of at least 3mm must be fitted on the mains supply • Check that there is an adequate residual current circuit breaker and a suitable overcurrent cut-out upstream of the electrical installation in accordance with Good Working Methods and with the laws in force. When requested, connect the automation to an effective earthing system that complies with current safety standards • During installation, maintenance and repair operations, cut off the



power supply before opening the cover to access the electrical parts • The electronic parts must be handled using earthed antistatic conductive arms. The manufacturer of the motorisation device declines all responsibility if component parts not compatible with safe and correct operation are fitted • Only use original spare parts when repairing or replacing products.

## 1.1 Safety functions

The Ditec LCU40H control panel has the following safety functions:

- obstacle recognition with force limiting;

The maximum response time of the safety functions is 0.5s.

The reaction time to a faulty safety function is 0.5s.

The safety functions comply with the standards and performance level indicated below:

EN ISO 13849-1:2015 Category 2 PL=c

EN ISO 13849-2:2012

The safety function cannot be bypassed either temporarily or automatically. Fault exclusion has not been applied.

## 2. EC Declaration of Conformity

ASSA ABLOY Entrance Systems AB declares that the Ditec LCU40H control panel complies with the fundamental requisites and other relevant requirements laid down by the following EC directives:

EMC Directive 2014/30/EU;

Low Voltage Directive 2014/35/EU;

RED Directive 2014/53/EU.

Signed for and on behalf of ASSA ABLOY Entrance Systems AB by:

|         |            |             |           |
|---------|------------|-------------|-----------|
| Place   | Date       | Signature   | Position  |
| Origgio | 2025/09/01 | Matteo Fino | CEO Ditec |



## 3. Technical specifications

|                                                                                                                      | LCU40H                                             | LCU40HJ                              |
|----------------------------------------------------------------------------------------------------------------------|----------------------------------------------------|--------------------------------------|
| <b>Power supply</b>                                                                                                  | 230V~ 50/60Hz                                      | 120V~ 50/60Hz                        |
| <b>Power absorption</b>                                                                                              | 0,6A                                               | 1,2A                                 |
| <b>Fuse</b>                                                                                                          | F2A                                                | 4A                                   |
| <b>Motor output</b>                                                                                                  | 24V ≡ 12 A max (X 2)                               |                                      |
| <b>Permanent power supply to accessories 0-30</b>                                                                    | 24V ≡ 0,15A                                        |                                      |
| <b>Power supply to accessories 0-1</b><br>(in any case, the total of accessories 0-30 and 0-1 must not exceed 0.5A). | 24V ≡ 0,5A continuous                              |                                      |
| <b>Ambient temperature</b>                                                                                           | -20°C - +55°C                                      |                                      |
| <b>Storable radio codes</b>                                                                                          | 100 / 200                                          | see RO → MU → 20/10 (paragraph 11.6) |
| <b>Radio frequency</b>                                                                                               | 433,92MHz                                          |                                      |
| <b>Degree of protection of the container</b>                                                                         | IP55                                               |                                      |
| <b>Product size</b>                                                                                                  | 238 x 357 x 120                                    |                                      |
| <b>Operating cycles</b>                                                                                              | Refer to the characteristics of the actuator used. |                                      |



**NOTE:** the given operating and performance features can only be guaranteed with the use of DITEC accessories and safety devices.

## 3.1 Applications

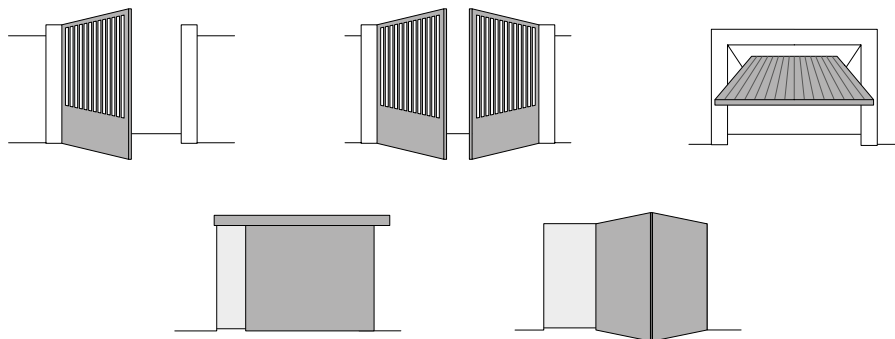

## 4. Installation and electrical connections

- Perforate the relevant points in the bottom part of the box (Fig. 4.1).
- Fix the control panel firmly in place. You are advised to use convex head screws (max head  $\varnothing$  10mm) with a cross imprint (the centre distance for the holes is shown in Fig. 4.2).
- Insert the cable glands and corrugated tubes from the lower side of the container.
- Before connecting the power supply, make sure the plate data correspond to those of the mains power supply.
- An omnipolar disconnection switch with a contact opening distance of at least 3mm must be fitted on the mains supply.
- Check there is an adequate residual current circuit breaker and overcurrent cut-out upstream of the electrical system.
- For the power supply, use a H05RN-F 3G1.5 type electric cable. Connect it to the terminals L (brown), N (blue),  $\oplus$  (yellow/green) inside the automation (Fig. 4.3, page 6).

**NOTE:** the maximum permitted wire section is AWG14 [2mm<sup>2</sup>].

- Unsheathe the part of the power supply cable in line with the terminal, and use a cable fastener to hold it in place [A].
- In order to comply with the essential requisites of the Standards in force, reclose the cover once the wires have been connected to the terminal.



The connections to the mains power supply and to any possible low voltage wires (230V) in the section outside the control panel must be made on an independent channel separated from the connections to the command and safety devices (SELV= Safety Extra Low Voltage). The corrugated tubes must enter the control panel by a few centimetres via the holes on the base box.

- Make sure there are no sharp edges that may damage the cables.
- Make sure the mains power wires (230V) and the accessory wires (24V) are separated.
- The cables must have dual insulation, be sheathed near the relative connection terminals, and be held in place with ties [B] (not supplied).
- If necessary, fit the clip hinges on the bottom of the box and on the cover (left or right side, as preferred) (Fig. 4.4, page 6).

After making the adjustments and settings, fix the cover in place with the screws supplied (Fig. 4.5, page 6).

Fig. 4.1

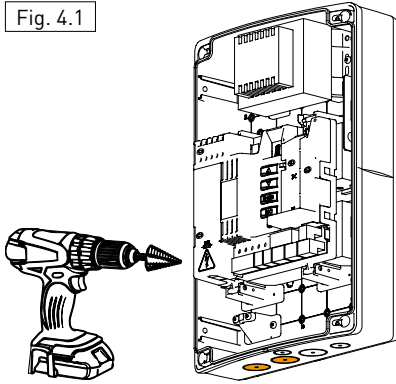

Fig. 4.2

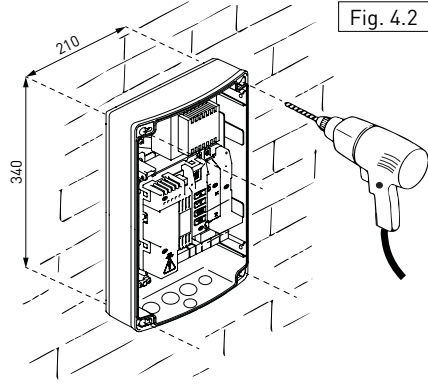

Fig. 4.3

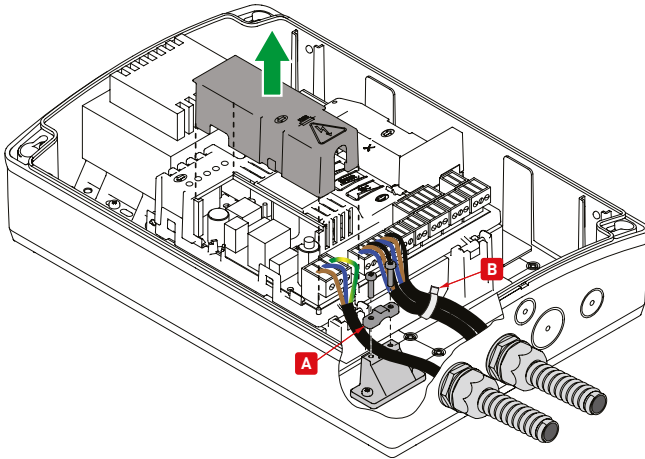

Fig. 4.4

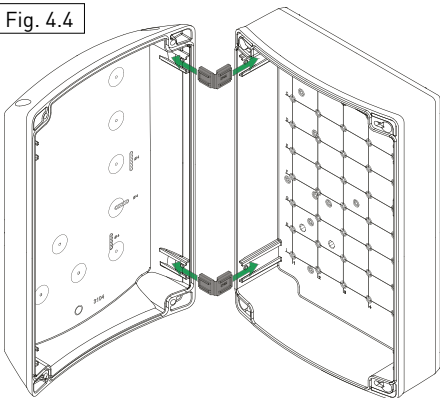
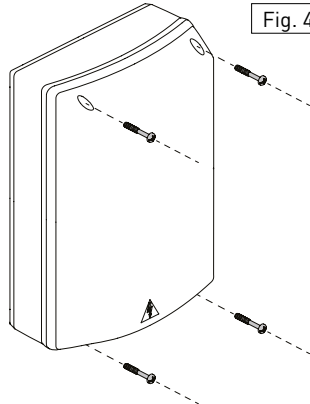

Fig. 4.5



## 4.1 Maintenance

The control panel needs no special maintenance.

Make regular checks to ensure the good condition of the box seals and the electrical connections.

## 4.2 Standard installation

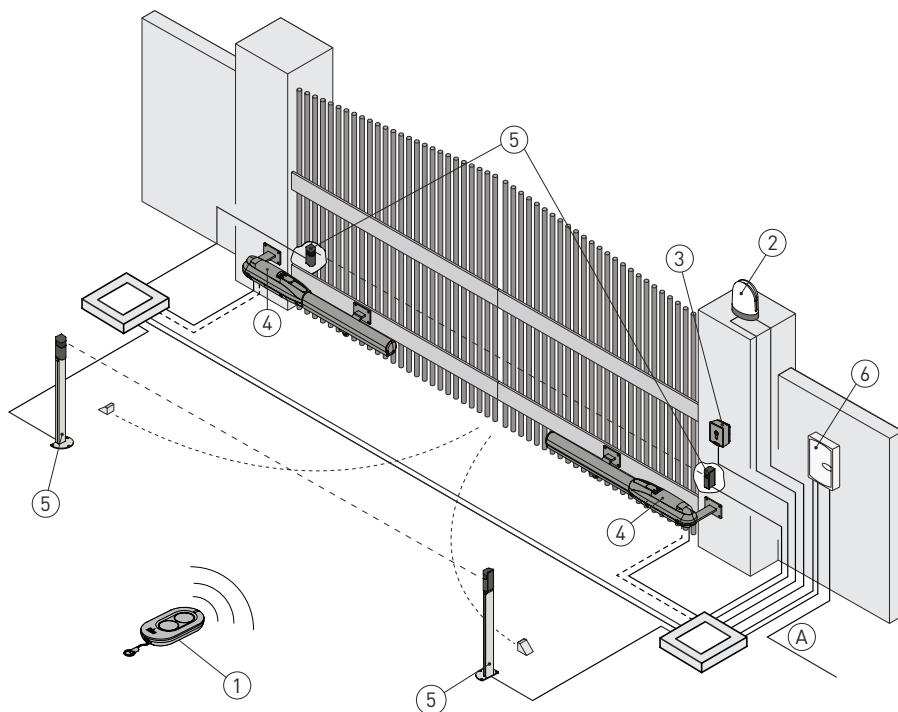

| Ref. | Description                                                                                                                                                                                                                                                 | Cable                   |
|------|-------------------------------------------------------------------------------------------------------------------------------------------------------------------------------------------------------------------------------------------------------------|-------------------------|
| 1    | Transmitter                                                                                                                                                                                                                                                 | /                       |
| 2    | Flashing light                                                                                                                                                                                                                                              | 2 x 1mm <sup>2</sup>    |
|      | Antenna (integrated in the flashing light)                                                                                                                                                                                                                  | coaxial 50 Ω            |
| 3    | Key selector switch                                                                                                                                                                                                                                         | 4 x 0.5mm <sup>2</sup>  |
|      | Digital combination wireless keypad                                                                                                                                                                                                                         | /                       |
| 4    | Actuator                                                                                                                                                                                                                                                    | 2 x 1.5mm <sup>2</sup>  |
|      | Actuator with limit switch                                                                                                                                                                                                                                  | 3 x 1.5mm <sup>2</sup>  |
| 5    | Photocells                                                                                                                                                                                                                                                  | 4 x 0.5mm <sup>2</sup>  |
| 6    | Control panel                                                                                                                                                                                                                                               | 3G x 1.5mm <sup>2</sup> |
| A    | Connect the power supply to a type-approved omnipolar switch, with a contact opening distance of at least 3mm (not supplied). Connection to the mains must be via an independent channel, separated from the connections to the command and safety devices. |                         |

### 4.3 Standard installation diagram

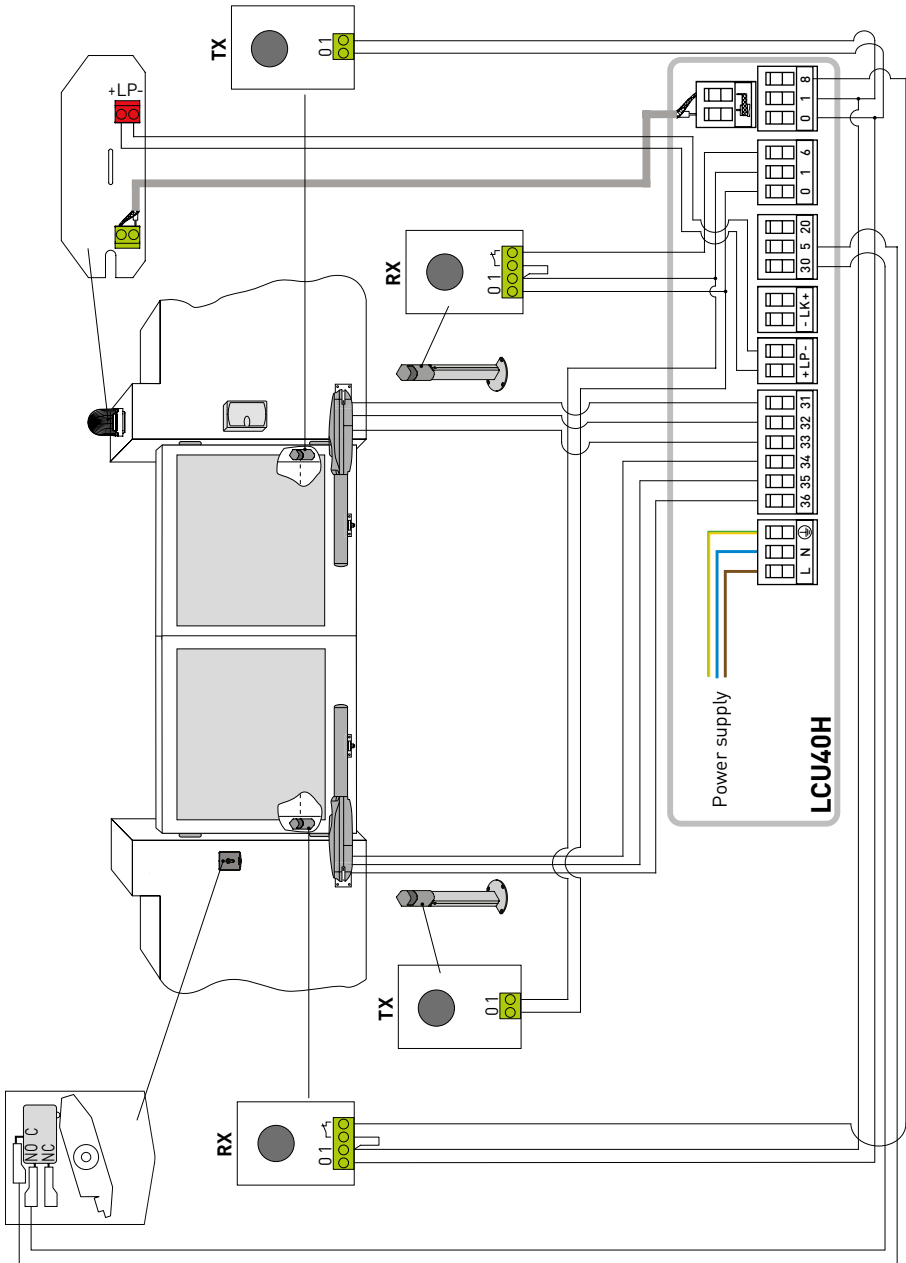

# 5. Programming



**NOTE:** pressure on the keys may be quick (less than 2s) or prolonged (longer than 2s). Unless specified otherwise, quick pressure is intended. To confirm the setting of a parameter, prolonged pressing is necessary.

## 5.1 Switching the display ON and OFF

The procedure to switch on the display is as follows:

- press the ENTER key
- the display functioning check starts
- the first level menu is displayed **AT**



The procedure to switch off the display is as follows:

- press the ESC key

**NOTE:** the display switches off automatically after 60s of inactivity.

## 5.2 Navigation keys

- The simultaneous pressing of the ↑ and ENTER keys produces an opening command.

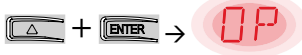

- The simultaneous pressing of the ↓ and ENTER keys produces a closing command.

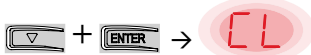

- The simultaneous pressing of the ↑ and ↓ keys produces a POWER RESET command (power supply interruption and automation restart).



- Keep the UP ↑ or DOWN ↓ key pressed to begin fast menu scrolling.
- In some menus, the parameter measurement unit can be viewed by pressing the ENTER key once the value has been displayed.

Example: setting of 10 seconds for parameter 0B.

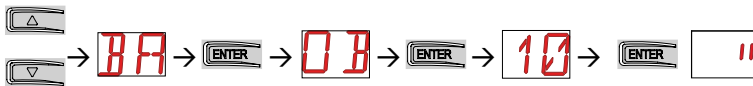

# 5.3 Menu map

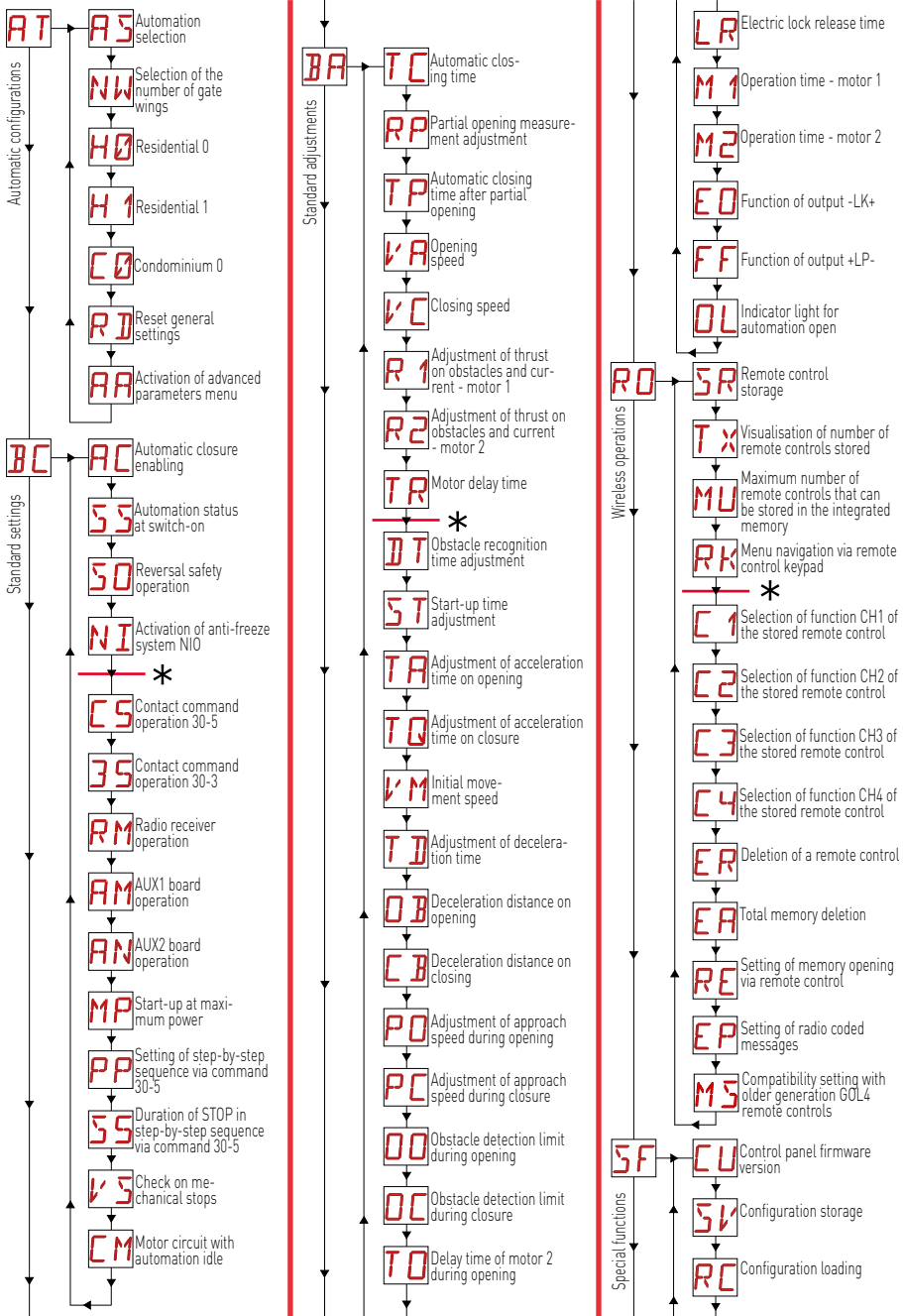

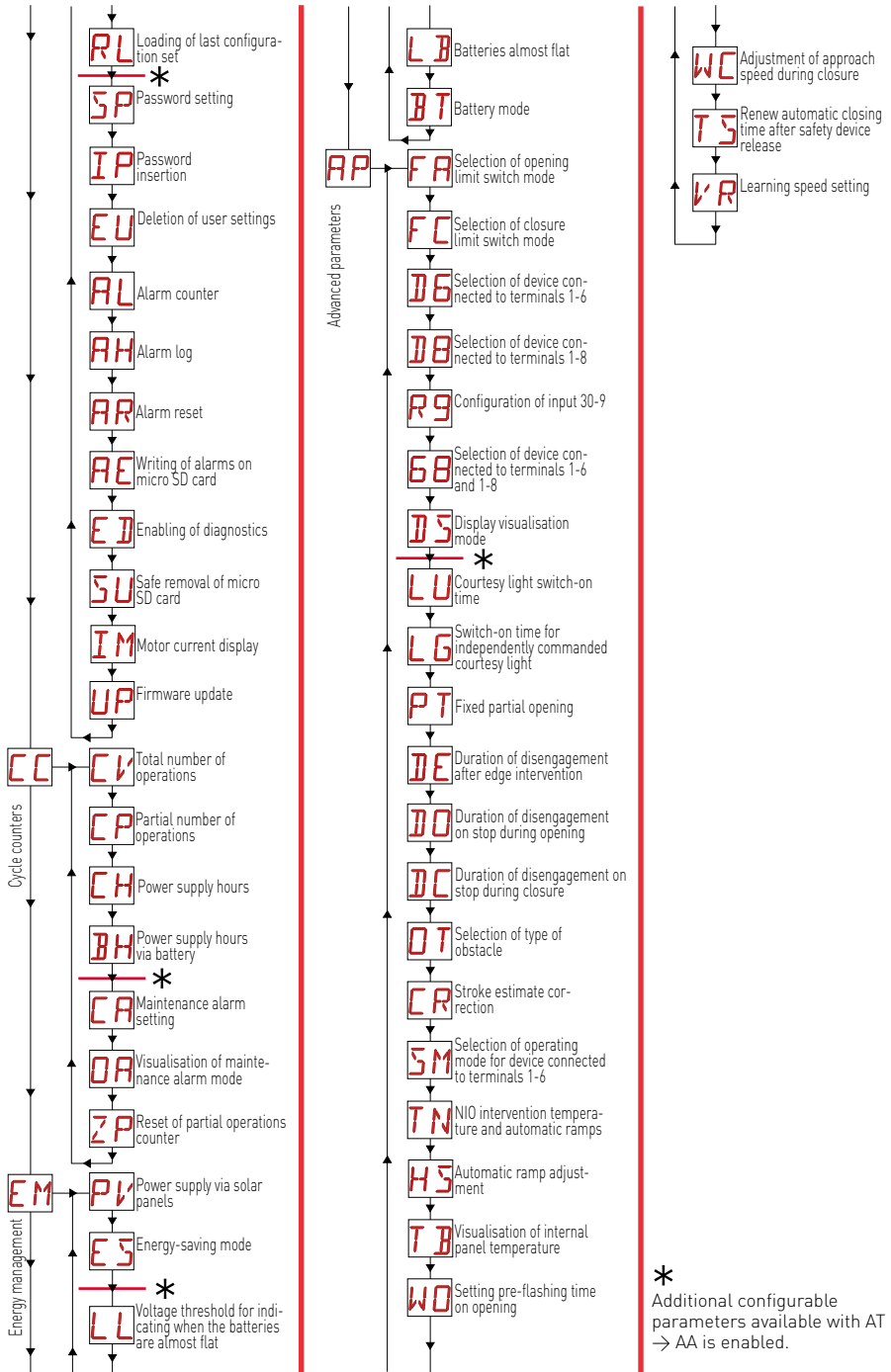

## 6. Quick start-up sequences

### 6.1 Selection of automation type

Example of PWR25 automation selection

Set

+ → **AT** → + → **AS** → + → **14** x2 s

Example of PWR35 automation selection

Set

+ → **AT** → + → **AS** → + → **15** x2 s

**NOTE:** if no automation is selected (alarm **M0** active) using the keys, you can access the values of parameter **AS** directly.

### 6.2 Configuration of the number of gate wings

Configuration example for a single gate wing

Set

+ → **AT** → + → **NW** → **0 1**

### 6.3 Enabling the configurations

Step-by-step mode without automatic closure (residential use)

+ → **AT** → + → **H0**

Step-by-step mode with automatic closure 1 min (residential use) [standard settings]

+ → **AT** → + → **H 1**

Opening mode with automatic closure 1 min (condominium use)

+ → **AT** → + → **C0**

### 6.4 Adding remote controls

+ → **RO** → + → **SR** x1, x2...

## 6.5 Configuration of the limit switches

### Example 1 - Door wing stops against mechanical end stops (standard setting)

Set

+ → **AP** → + **FA** → → **NO** **OK**  
 + → **AP** → + **FC** → → **NO** **OK**

### Example 2 - Door wing stops against limit switches

Set

+ → **AP** → + **FA** → → **SX** **OK**  
 + → **AP** → + **FC** → → **SX** **OK**

With these settings, if an obstacle is detected while the gate wing is opening, it stops with a disengagement operation; during closure, the gate wing reopens.

### Example 3 - Door wing stops against mechanical end stops and reverses motion if an obstacle is detected

Set

+ → **AP** → + **FA** → → **SX** **OK**  
 + → **AP** → + **FC** → → **PX** **OK**

With these settings, the gate wing stops against its respective mechanical closing end stop and the opening limit switch.

If an obstacle is detected during the opening and before the activation of the stop limit switch, the gate wing stops with a disengagement operation.

If an obstacle is detected during closure and before the activation of the proximity limit switch, the gate wing reopens; once the proximity limit switch has been activated, the gate wing stops against the obstacle.

## 6.6 Configuration of the safety devices

### Example 1 - Configuration of the photocells connected to terminals 1-8 and 1-6 [standard settings]

Set

+ → **AP** → + **D8** → → **PH** **OK**  
 + → **AP** → + **D6** → → **PH** **OK**

### Example 2 - Configuration of the safety edge with safety test simultaneously connected to terminals 1-6 and 1-8

Set

+ → **AP** → + **E8** → → **S4** **OK**

# 7. Application examples



**WARNING:** Ensure that the forces exerted by the door wings are compliant with EN12453-EN12445 regulations.

## 7.1 Automations with two swinging gates

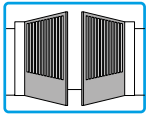

When the Ditec LCU40H control panel is used in applications for automations with two overlapping swinging gate wings, the following connections can be made:

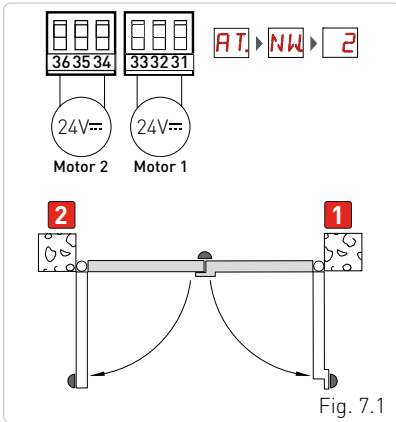

Fig. 7.1

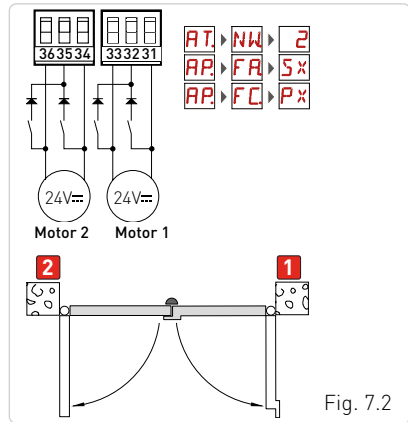
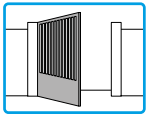

Fig. 7.2

(Fig. 7.1) Installation with mechanical end stops for opening and closure, and without the use of electric limit switches.

(Fig. 7.2) Installation with mechanical end stop for closure, and with the use of electric limit switches (stop during opening and proximity during closure).

## 7.2 Automations with one swinging gate wing



When the Ditec LCU40H control panel is used in applications for automations with one swinging gate wing, the following connections can be made:

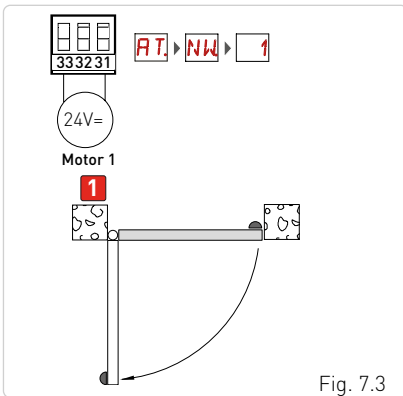

Fig. 7.3

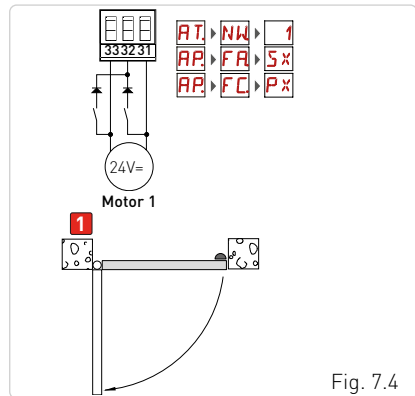
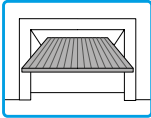

Fig. 7.4

(Fig. 7.3) Installation with mechanical end stops for opening and closure, and without the use of electric limit switches.

(Fig. 7.4) Installation with mechanical end stop for closure, and with the use of electric limit switches (stop during opening and proximity during closure).

## 7.3 Up-and-over doors with two parallel motors



When the Ditec LCU40H control panel is used in applications for automations with up-and-over doors with two parallel motors, the following connections can be made:

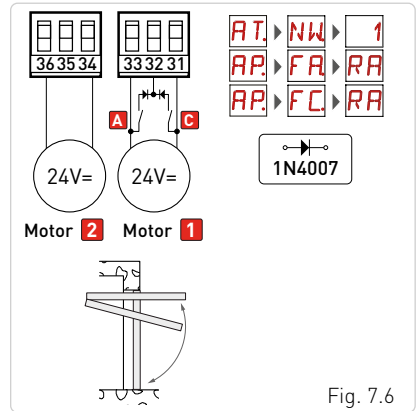
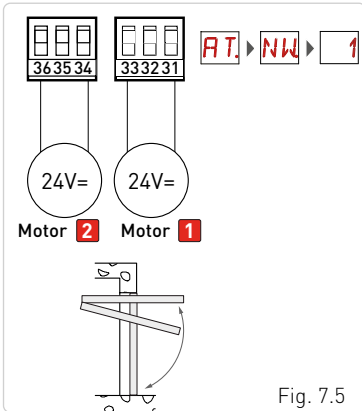

[Fig. 7.5] Installation with mechanical end stops for opening and closure, and without the use of electric limit switches.

[Fig. 7.6] Installation with electric limit switches for deceleration during opening and closure.

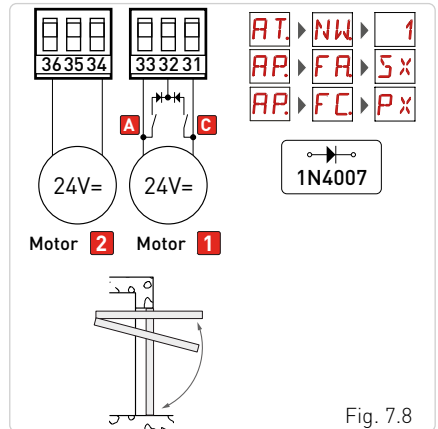
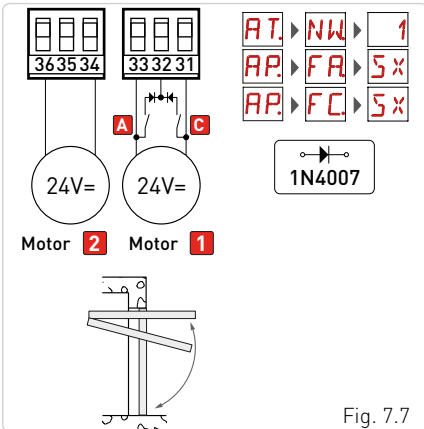

[Fig. 7.7] Installation with electric limit switches (stop during opening and closure).

[Fig. 7.8] Installation with electric limit switches (stop during opening and proximity during closure).











## 8. Commands



You are advised to read paragraph 11 for all the details about the possible adjustments.



**WARNING:** terminal 30 (common positive for commands) has the same functions as terminal 1, so the commands visible on the display are indicated with 1-5, 1-3, 1-4, etc. It is different from terminal 1, however, because of the maximum current that can be dispensed and it is also active when the control panel is in standby  $E5 \rightarrow ON$ .

| Command                                                                                        | Function                          | Description                                                                                                                                                                                                                                                                                                                                                                                                                               |
|------------------------------------------------------------------------------------------------|-----------------------------------|-------------------------------------------------------------------------------------------------------------------------------------------------------------------------------------------------------------------------------------------------------------------------------------------------------------------------------------------------------------------------------------------------------------------------------------------|
| 30  2 NO      | AUTOMATIC CLOSURE                 | The permanent closure of the contact enables automatic closure if $AC \rightarrow I-2$                                                                                                                                                                                                                                                                                                                                                    |
| 30  3 NO      | OPENING                           | When selecting $BC \rightarrow 3S \rightarrow I-3$ , the closure of the contact activates an opening operation.                                                                                                                                                                                                                                                                                                                           |
|                                                                                                | STEP-BY-STEP                      | When selecting $BC \rightarrow 3S \rightarrow I-5$ , the closure of the contact activates a sequential opening or closing operation: opening-stop-closing-opening. The "opening-stop-closing-opening" sequence can be changed to "opening-stop-closing-stop-opening" by selecting $BC \rightarrow PP$ .                                                                                                                                   |
| 30  4 NO      | CLOSURE                           | The closure of the contact activates a closing operation.                                                                                                                                                                                                                                                                                                                                                                                 |
| 30  5 NO      | STEP-BY-STEP                      | When selecting $BC \rightarrow CS \rightarrow I-5$ , the closure of the contact activates a sequential opening or closing operation: opening-stop-closing-opening.<br><b>WARNING:</b> if automatic closure is enabled, the duration of the stop can be defined by selecting $BC \rightarrow 5S$ .<br>The "opening-stop-closing-opening" sequence can be changed to "opening-stop-closing-stop-opening" by selecting $BC \rightarrow PP$ . |
|                                                                                                | OPENING                           | When selecting $BC \rightarrow CS \rightarrow I-3$ , the closure of the contact activates an opening operation.                                                                                                                                                                                                                                                                                                                           |
| 1  6 NC       | SAFETY STOP                       | The opening of the safety contact stops and prevents any movement.<br><b>NOTE:</b> $APSM$ to set different safety contact functions, see the $\rightarrow$ parameter settings.                                                                                                                                                                                                                                                            |
| 1  8 NC       | CLOSING SAFETY DEVICE             | The opening of the safety contact triggers a reversal of the movement (reopening) during the closing operation.                                                                                                                                                                                                                                                                                                                           |
|                                                                                                |                                   | When selecting $BC \rightarrow SO \rightarrow ON$ , the opening of the contact prevents any operation when the automation is idle.<br>When selecting $BC \rightarrow SO \rightarrow OF$ , the opening of the contact only prevents closure when the automation is idle.                                                                                                                                                                   |
| 1  6<br>8 NC | CLOSING/<br>OPENING SAFETY DEVICE | The opening of the safety contact stops and prevents any movement.<br><b>NOTE:</b> operation corresponds to that of contact 1-6 with $AP \rightarrow SM \rightarrow OS$ .                                                                                                                                                                                                                                                                 |
| 30  9 NC    | STOP                              | The opening of the safety contact causes the current operation to stop.<br>If $AP - R9 = 9P$ , automatic closure is disabled when contact 30-9 recloses.<br>If $AP - R9 = 9T$ , automatic closure remains enabled when contact 30-9 recloses.                                                                                                                                                                                             |
| 30  9 NO    | "OPERATOR PRESENT" COMMAND        | When selecting $AP \rightarrow R9 \rightarrow HR$ , the opening of contact 30-9 enables the "operator present" function:<br>- opening with operator present 30-3<br>- closure with operator present 30-4<br><b>NOTE:</b> any safety devices, automatic closure and plug-in board in the AUX housing are all disabled.                                                                                                                     |
| 30  20 NO   | PARTIAL OPENING                   | The closure of the contact activates a partial opening operation. Once the automation stops, the partial opening control performs the opposite operation to the one performed before the stop.                                                                                                                                                                                                                                            |



**WARNING:** make a jumper for all NC contacts if not used, or deactivate them via the relative menu. Terminals with the same number are equal.

## 8.1 Inserting plug-in boards (AUX)

To access the slots for plug-in boards (AUX):



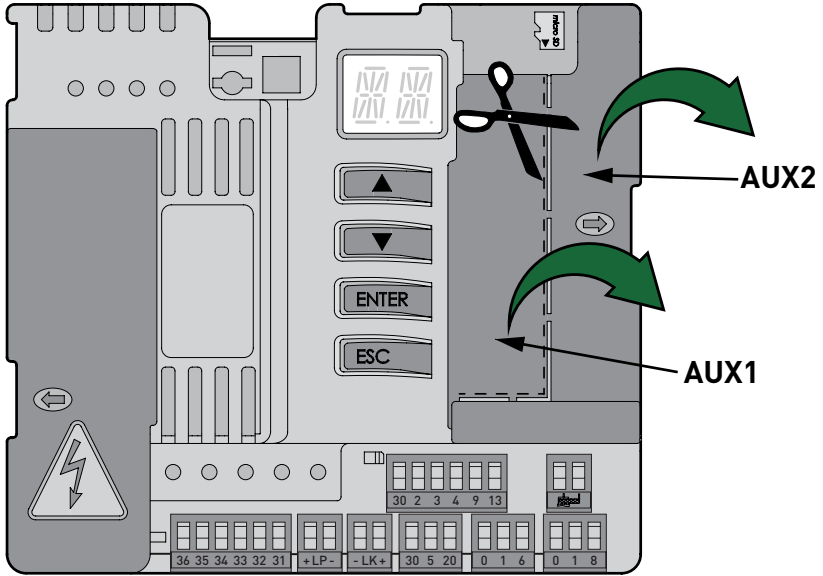

- If you want to insert just one board, cut the control panel cover and remove it as shown in the figure.
- If both slots are needed, remove the cover completely.



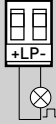
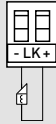
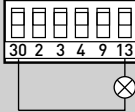

## 8.2 SOFA1-SOFA2 or GOPAVRS self-controlled safety edge

| Command |    | Function                       | Description                                                                                                                                                                                                                                                                                          |
|---------|----|--------------------------------|------------------------------------------------------------------------------------------------------------------------------------------------------------------------------------------------------------------------------------------------------------------------------------------------------|
|         |    | SAFETY TEST                    | Insert the SOFA1-SOFA2 or GOPAVRS device in the slot for plug-in boards AUX1 or AUX2.<br>If the test fails, an alarm message appears on the display.                                                                                                                                                 |
|         | NC | SAFETY STOP                    | When selecting <b>AP</b> → <b>DB</b> → <b>54I</b> , connect the output contact of the safety device to terminals 1-6 on the control panel (in series with the photocell output contact, if installed).                                                                                               |
|         | NC | CLOSING SAFETY DEVICE          | When selecting <b>AP</b> → <b>DB</b> → <b>54I</b> , connect the output contact of the safety device to terminals 1-8 on the control panel (in series with the photocell output contact, if installed).                                                                                               |
|         | NC | CLOSING/ OPENING SAFETY DEVICE | When selecting <b>AP</b> → <b>6B</b> → <b>54I</b> , connect the output contact of the safety device to terminals 1-6-8 on the control panel (in series with the photocell output contact, if installed).<br>If <b>6B</b> → <b>54I</b> , <b>DB</b> and <b>DB</b> cannot be <b>P4I</b> or <b>54I</b> . |



## 9. Outputs and accessories

| Output                                                                                     | Value of accessories                                                   | Description                                                                                                                                                                                                                                                                                                                                                                                                                                                                                                                  |
|--------------------------------------------------------------------------------------------|------------------------------------------------------------------------|------------------------------------------------------------------------------------------------------------------------------------------------------------------------------------------------------------------------------------------------------------------------------------------------------------------------------------------------------------------------------------------------------------------------------------------------------------------------------------------------------------------------------|
|           | 24V $\overline{\text{=}}$ / 0.5 A                                      | <p><b>Power supply to accessories</b><br/>Output for power supply to external accessories.<br/><b>NOTE:</b> the maximum absorption of 0.5A corresponds to the sum of all terminals 1.<br/>The "gate open" indicator light (30-13) is not calculated in the 0.5A indicated above. The maximum value to be considered is 3W.</p>                                                                                                                                                                                               |
|           | GOL148REA                                                              | If the GOL868R4 radio receiver is used (868.35 MHz), connect the supplied antenna wire (90mm).                                                                                                                                                                                                                                                                                                                                                                                                                               |
|           | FL24<br>24V $\overline{\text{=}}$ / 25W                                | <p><b>Configurable 24V<math>\overline{\text{=}}</math> output (default: flashing)</b><br/>The pre-flashing settings can be selected from the third level menu <b>AP</b> <math>\rightarrow</math> <b>WO</b> and/or <b>AP</b> <math>\rightarrow</math> <b>WC</b>.<br/>To modify the operating mode of the LP output, refer to the selection <b>BA</b> <math>\rightarrow</math> <b>FF</b>.</p> <p><b>i NOTE:</b> compatible with 12/24 V- electric locks</p>                                                                    |
|           | 24V $\overline{\text{=}}$ / 15W                                        | <p><b>Configurable 24V<math>\overline{\text{=}}</math> output (default: electric lock)</b><br/>It is activated when the operation begins with the automation closed.<br/>To modify the operating mode of the LK output, refer to the selection <b>BA</b> <math>\rightarrow</math> <b>EO</b>.</p> <p><b>i NOTE:</b> compatible with 12/24 V- electric locks</p>                                                                                                                                                               |
|           | 24V $\overline{\text{=}}$ / 3W                                         | <p><b>Automation status lamp</b><br/>For the operating mode of output 30-13, refer to the selection <b>BA</b> <math>\rightarrow</math> <b>OL</b>.</p>                                                                                                                                                                                                                                                                                                                                                                        |
| AUX 1<br>AUX 2                                                                             | BIXR2<br>BIXPR2<br>LAB9<br>LAN7S<br>MOBCRE<br>SOFA1 – SOFA2<br>GOPAVRS | <p><b>The control panel has two slots for plug-in command and safety boards.</b><br/>The action of the control board can be selected using <b>BC</b> <math>\rightarrow</math> <b>AM</b> for AUX1 and <b>BC</b> <math>\rightarrow</math> <b>AN</b> for AUX2.<br/>When using slot-in radio boards, remove the RDX module. The display will show <b>RY</b>.<br/><b>WARNING:</b> the plug-in board must be inserted and removed with the power supply disconnected.<br/><b>WARNING:</b> BIXLR42 not compatible with AUX slot</p> |
| RDX<br> | ZENRS<br>ZENPRS                                                        | <p>The control panel is fitted with a housing for modules of the ZENRS radio receiver type (433.92MHz).<br/>Can be replaced with a radio receiver module of the ZENPRS type (868.35MHz).<br/>The operating mode is selected via <b>BC</b> <math>\rightarrow</math> <b>RM</b>.<br/>When using slot-in radio boards, remove the RDX module. The display will show <b>RY</b>.<br/><b>Warning:</b> the modules must be inserted and removed with the power supply disconnected.</p>                                              |

| Output                                                                            | Value of accessories | Description                                                                                                                                                                                                                                                                                                                                                                                                                                                                                                                                                                                                                                    |
|-----------------------------------------------------------------------------------|----------------------|------------------------------------------------------------------------------------------------------------------------------------------------------------------------------------------------------------------------------------------------------------------------------------------------------------------------------------------------------------------------------------------------------------------------------------------------------------------------------------------------------------------------------------------------------------------------------------------------------------------------------------------------|
|  | MicroSD              | The control panel manages microSD cards for updating the firmware and for diagnostics and configuration storage/recovery via the in commands <b>SF</b> → <b>SP</b> and <b>SF</b> → <b>RC</b> .<br><b>NOTE:</b> use a microSD with a maximum capacity no greater than 16 Gb.                                                                                                                                                                                                                                                                                                                                                                    |
|  | BIXMR2               | <b>COM</b> - This allows the functioning configurations to be saved using the function <b>SF</b> → <b>SP</b> .<br>The saved configurations can be recalled using the function <b>SF</b> → <b>RC</b> .<br><b>COM</b> - The storage module allows the remote controls to be stored. If the control panel is replaced, the storage module being used can be inserted in the new control panel.<br><b>WARNING:</b> the storage module must be inserted and removed with the power supply disconnected, and paying attention to the positioning direction.                                                                                          |
|  | SBU                  | <b>BAT - Battery-powered operation.</b><br>The batteries are kept charged when the power supply is on. If the power supply is off, the panel is powered by the batteries until the power is re-establish or until the battery voltage drops below the safety threshold. The panel turns off in the last case.<br><b>WARNING:</b> the batteries must always be connected to the control panel for charging. Periodically check the efficiency of the batteries.<br><b>NOTE:</b> the operating temperature of the rechargeable batteries is from +5°C to +40°C. For advanced control of battery-powered operation, refer to the menu <b>EM</b> . |

## 10. Jumper setting

| Jumper | Description            | OFF                                                                              | ON                                                                                                                                                                                                              |
|--------|------------------------|----------------------------------------------------------------------------------|-----------------------------------------------------------------------------------------------------------------------------------------------------------------------------------------------------------------|
| JR1    | Display mode selection | <b>Display mode.</b><br>Only the values and parameters present can be displayed. | <b>Maintenance mode.</b><br>Only the values and parameters present can be displayed and modified. Activated maintenance mode is indicated by the permanent switching on of the right-hand point on the display. |

| Jumper | Description                                   |  |  |
|--------|-----------------------------------------------|-------------------------------------------------------------------------------------|-------------------------------------------------------------------------------------|
| AUX1   | Selection of power supply - auxiliary board 1 | AUX1 powered from 0-1.                                                              | AUX1 powered from 0-30.                                                             |
| AUX2   | Selection of power supply - auxiliary board 2 | AUX2 powered from 0-1.                                                              | AUX2 powered from 0-30.                                                             |



# 11. Adjustments

**i** **NOTE:** depending on the type of automation and control panel, some menus may not be available.

## 11.1 Main menu

| Display | Description                                                                                                                                                                                                                                                                                                                                                                         |
|---------|-------------------------------------------------------------------------------------------------------------------------------------------------------------------------------------------------------------------------------------------------------------------------------------------------------------------------------------------------------------------------------------|
| AT      | <b>AT - Automatic Configurations.</b><br>The menu allows you to manage the automatic configurations of the control panel.                                                                                                                                                                                                                                                           |
| BC      | <b>BC - Basic Configurations.</b><br>The menu allows you to display and modify the main settings of the control panel.                                                                                                                                                                                                                                                              |
| BA      | <b>BA - Basic Adjustments.</b><br>The menu allows you to display and modify the main adjustments of the control panel.<br><b>NOTE:</b> some settings require at least three operations before they are set correctly.                                                                                                                                                               |
| RO      | <b>RO - Radio Operations.</b><br>The menu is used to manage the radio functions of the control panel (alarm management, diagnostics enabling, FW updating).                                                                                                                                                                                                                         |
| SF      | <b>SF - Special Functions.</b><br>The menu allows you to set the password and manage the special functions in the control panel.                                                                                                                                                                                                                                                    |
| CC      | <b>CC - Cycles Counter.</b><br>The menu allows you to display the number of operations carried out by the automation and manage the maintenance interventions.                                                                                                                                                                                                                      |
| EM      | <b>EM - Energy Management.</b><br>The menu allows you to display and modify the energy saving settings and adjustments (Green Mode and battery management).                                                                                                                                                                                                                         |
| AP      | <b>AP - Advanced Parameters.</b><br>The menu allows you to display and modify the advanced settings and adjustments of the control panel (limit switch mode, selection of devices connected to the terminals, disengagement duration adjustments, flashing light adjustments, etc.).<br><b>NOTE:</b> some settings require at least three operations before they are set correctly. |

From the main menu you can access the second level menu as follows:



- use the  and  keys to select the required function
- press  to confirm

After confirming the selection, you access the second level menu.

For each function of the main menu, there are also additional configurations that can be viewed by enabling the **AA** function (see the following paragraph).

**i** **NOTE:** to check if the parameters have actually been modified, quit the relative parameter and then access it again. The modifications will take effect from the next operation.

## 11.2 Second level menu - AT (Automatic Configurations)

| AT - Automatic configurations | Display                                                                                                                                                                                                                                                                                                                                                                                                                                                                                                | Description                                                                                                                                                                                                                                                                                               | Selections available |           |
|-------------------------------|--------------------------------------------------------------------------------------------------------------------------------------------------------------------------------------------------------------------------------------------------------------------------------------------------------------------------------------------------------------------------------------------------------------------------------------------------------------------------------------------------------|-----------------------------------------------------------------------------------------------------------------------------------------------------------------------------------------------------------------------------------------------------------------------------------------------------------|----------------------|-----------|
|                               | <b>AS</b>                                                                                                                                                                                                                                                                                                                                                                                                                                                                                              | <b>AS - Automation selection</b><br>This selection pre-sets the type of motor and a sub-set of parameters linked to the kinematic mechanism of the automation for a standard installation.<br>See "Selection of automation type", paragraph 11.3.<br>Each parameter can still be modified when necessary. | <b>NO 18</b>         |           |
| <b>NW</b>                     | <b>NW - Selection of the number of gate wings</b><br>In the case of automations with a single gate wing, connect motor 1.                                                                                                                                                                                                                                                                                                                                                                              | <b>0 1 0 2</b>                                                                                                                                                                                                                                                                                            |                      |           |
| <b>H0</b>                     | <b>H0 - Predefined setting, residential use 0</b><br>This selection loads predefined values for certain standard parameters:<br><b>AC</b> - enabling of automatic closing : 1-2<br><b>C5</b> - step-by-step/opening command operation: step-by-step<br><b>RM</b> - remote control operation : step-by-step<br><b>AM</b> - AUX plug-in board operation : step-by-step<br><b>SS</b> - Selection of automation status at start-up: open                                                                   |                                                                                                                                                                                                                                                                                                           |                      |           |
| <b>H1</b>                     | <b>H1 - Predefined setting, residential use 1</b><br>This selection loads predefined values for certain standard parameters:<br><b>AC</b> - enabling of automatic closing : enabled<br><b>TC</b> - setting of automatic closing time : 1 minute<br><b>C5</b> - step-by-step/opening command operation: step-by-step<br><b>RM</b> - remote control operation : step-by-step<br><b>AM</b> - AUX plug-in board operation : step-by-step<br><b>SS</b> - Selection of automation status at start-up: closed |                                                                                                                                                                                                                                                                                                           |                      |           |
| <b>C0</b>                     | <b>C0 - Predefined setting, condominium use 0</b><br>This selection loads predefined values for certain standard parameters:<br><b>AC</b> - Enabling of automatic closure : enabled<br><b>TC</b> - setting of automatic closing time : 1 minute<br><b>C5</b> - step-by-step/opening command operation: Opening<br><b>RM</b> - remote control operation : Opening<br><b>AM</b> - AUX plug-in board operation : Opening<br><b>SS</b> - Selection of automation status at start-up: closed                |                                                                                                                                                                                                                                                                                                           |                      |           |
| <b>RD</b>                     | <b>RD - Resetting of general settings (SETTINGS RESET)</b><br>                                                                                                                                                                                                                                                                                                                                                       |                                                                                                                                                                                                                                                                                                           |                      |           |
| <b>AA</b>                     | <b>AA - Activation of additional configurable parameters for each function of the main menu.</b><br><br>After activation you can scroll through the third level menus.<br>The third level menus are activated for 30 min.                                                                                                                                                                                           | <b>AA</b>                                                                                                                                                                                                                                                                                                 | <b>AA</b>            | <b>AA</b> |

## 11.2.1 Selection of automation type **AT** → **AS** and specific default settings

| <b>AS</b> | <b>Type of automation</b> | <b>Model</b>                               | <b>CM</b>            | <b>R1-R2</b>                           | <b>VA-VC</b>                            | <b>VR</b>             | <b>PO-PC</b>          | <b>TA</b>                               | <b>TQ</b>                               | <b>VM</b>                  |
|-----------|---------------------------|--------------------------------------------|----------------------|----------------------------------------|-----------------------------------------|-----------------------|-----------------------|-----------------------------------------|-----------------------------------------|----------------------------|
|           |                           |                                            | <b>Motor circuit</b> | <b>Thrust on obstacles and current</b> | <b>Speed during opening and closure</b> | <b>Learning speed</b> | <b>Approach speed</b> | <b>Acceleration time during opening</b> | <b>Acceleration time during closure</b> | <b>Ramp start-up speed</b> |
| <b>01</b> |                           | OBB13BH                                    |                      | 50                                     | 24                                      | 18                    | 07                    | 2                                       | 3                                       | 03                         |
| <b>02</b> |                           | ARCBH                                      |                      | 70                                     | 14                                      | 10                    | 06                    | 2                                       | 3                                       | 03                         |
| <b>03</b> |                           | FACIL3H                                    | CL                   | 50                                     | 12                                      | 10                    | 05                    | 2                                       | 3                                       | 03                         |
| <b>04</b> |                           | LUX03BH-4BH                                |                      | 40                                     | 16                                      | 12                    | 06                    | 1                                       | 2                                       | 10                         |
| <b>05</b> |                           | LUX05BH-5VBH (gate wing < 300 Kg or 3.5 m) | OP                   | 40                                     | 15                                      | 10                    | 06                    | 1                                       | 2                                       | 10                         |
| <b>06</b> |                           | LUX05BH (gate wing > 300 Kg or 3.5 m)      |                      | 50                                     | 12                                      | 08                    | 05                    | 1                                       | 2                                       | 10                         |
| <b>07</b> |                           | ARC1BH (gate wing < 250 Kg & 3 m)          |                      | 50                                     | 08                                      | 06                    | 05                    | 2                                       | 3                                       | 03                         |
| <b>08</b> |                           | ARC1BH (gate wing > 250 Kg or 3 m)         |                      | 60                                     | 06                                      | 05                    | 04                    | 2                                       | 3                                       | 03                         |
| <b>09</b> |                           | DOR1BH-1BHS (gate wing < 300 Kg or 1+1 m)  | CL                   | 50                                     | 08                                      | 06                    | 05                    | 2                                       | 4                                       | 03                         |
| <b>10</b> |                           | DOR1BH-1BHS (gate wing > 300 Kg or 1+1 m)  |                      | 60                                     | 06                                      | 05                    | 04                    | 3                                       | 6                                       | 02                         |
| <b>11</b> |                           | CUBIC6H-6HV-30H                            |                      | 60                                     | 12                                      | 08                    | 06                    | 2                                       | 3                                       | 05                         |
| <b>12</b> |                           | BOX3SH                                     |                      | 50                                     | 10                                      | 06                    | 05                    | 1                                       | 5                                       | 03                         |
| <b>13</b> |                           | DOKE                                       | OP                   | 50                                     | 15                                      | 08                    | 05                    | 1                                       | 1                                       | 03                         |
| <b>14</b> |                           | PWR25H                                     |                      | 50                                     | 18                                      | 10                    | 05                    | 2                                       | 3                                       | 03                         |
| <b>15</b> |                           | PWR35H                                     | CL                   | 50                                     | 20                                      | 12                    | 06                    | 2                                       | 3                                       | 03                         |
| <b>16</b> |                           | PWR50H (gate wing < 300 Kg or 3.5 m)       |                      | 40                                     | 15                                      | 10                    | 06                    | 1                                       | 2                                       | 10                         |
| <b>17</b> |                           | PWR50H (gate wing > 300 Kg or 3.5 m)       | OP                   | 50                                     | 12                                      | 8                     | 05                    | 1                                       | 2                                       | 10                         |
| <b>18</b> |                           | PWR40H                                     | CL                   | 40                                     | 22                                      | 15                    | 06                    | 1                                       | 2                                       | 10                         |
| <b>19</b> |                           | PWR50HR (gate wing < 300 Kg or 3.5 m)      |                      | 40                                     | 15                                      | 10                    | 06                    | 1                                       | 2                                       | 10                         |
| <b>20</b> |                           | PWR50HR (gate wing > 300 Kg or 3.5 m)      | OP                   | 50                                     | 12                                      | 8                     | 05                    | 1                                       | 2                                       | 10                         |

## 11.3 Second level menu - BC (Basic Configurations)

| BC - Basic configurations | Display | Description                                                                                                                                                                                                                                                                                                                                                                                                 | Selections available |
|---------------------------|---------|-------------------------------------------------------------------------------------------------------------------------------------------------------------------------------------------------------------------------------------------------------------------------------------------------------------------------------------------------------------------------------------------------------------|----------------------|
|                           | AC      | <b>AC - Enabling of automatic closure</b><br>ON - Enabled<br>1-2 - Dependent on input 30-2                                                                                                                                                                                                                                                                                                                  | ON 1-2<br>—          |
|                           | SS      | <b>SS - Selection of automation status at start</b><br>OP - Open<br>CL - Closed<br>Indicates how the control panel considers the automation at the time of switch-on, or after a POWER RESET command.                                                                                                                                                                                                       | OP CL<br>—           |
|                           | SO      | <b>SO - Enabling of reversal safety contact functioning</b><br>ON - Enabled<br>OF - Disabled<br>When enabled (ON) with the automation idle, if the contact 1-8 is open, all operations are prevented.<br>When disabled (OF) with the automation idle, if the contact 1-8 is open, opening operations are permitted.                                                                                         | ON<br>OF<br>—        |
|                           | NI      | <b>NI - Enabling of NIO electronic anti-freeze system</b><br>ON - Enabled<br>OF - Disabled<br>When enabled (ON), it maintains the efficiency of the motor even at low ambient temperatures.<br><b>NOTE:</b> for correct operation, the control panel must be exposed to the same ambient temperature as the motors.<br>The intervention temperature for NIO can be set by selecting <b>AP</b> → <b>TN</b> . | ON<br>OF<br>—        |

### 11.3.1 Additional BC level parameters that can be configured (available with **AT** → **AA** enabled)



| BC - Basic configurations | Display                                                                                                     | Description                                                                                                                                                                                               | Selections available |
|---------------------------|-------------------------------------------------------------------------------------------------------------|-----------------------------------------------------------------------------------------------------------------------------------------------------------------------------------------------------------|----------------------|
|                           | C5                                                                                                          | <b>C5 - Operation of command associated with contact 30-5</b><br>1-5 - Step-by-step<br>1-3 - Opening                                                                                                      | 1-5 1-3<br>—         |
|                           | 35                                                                                                          | <b>35 - Operation of command associated with contact 30-3</b><br>1-5 - Step-by-step<br>1-3 - Opening                                                                                                      | 1-3 1-5<br>—         |
|                           | RM                                                                                                          | <b>RM - Radio receiver operation</b><br>1-5 - Step-by-step<br>1-3 - Opening                                                                                                                               | 1-5 1-3<br>—         |
|                           | AM                                                                                                          | <b>AM - Operation of AUX1 plug-in control board</b><br>1-5 - Step-by-step<br>1-3 - Opening                                                                                                                | 1-5 1-3<br>—         |
|                           | AN                                                                                                          | <b>AN - Operation of AUX2 plug-in control board</b><br>1-5 - Step-by-step<br>1-3 - Opening                                                                                                                | 1-5 1-3<br>—         |
|                           | MP                                                                                                          | <b>MP - Start-up at maximum power</b><br>ON - During start-up it increases the thrust on obstacles to maximum<br>OFF - During start-up, the thrust on obstacles is at the level adjusted by <b>R 1-R2</b> | ON OFF<br>—          |
|                           | PP                                                                                                          | <b>PP - Setting step-by-step sequence from command 30-5</b><br>ON - Opening-Stop-Closing-Stop-Opening<br>OF - Opening-Stop-Closing-Opening                                                                | ON OF<br>—           |
| SS                        | <b>S5 - Duration of STOP in step-by-step sequence from command 30-5</b><br>ON - Permanent<br>OF - Temporary | ON OF<br>—                                                                                                                                                                                                |                      |

| Display | Description                                                                                                                                                                                                                                                                                                                                                                                                                                  | Selections available                |
|---------|----------------------------------------------------------------------------------------------------------------------------------------------------------------------------------------------------------------------------------------------------------------------------------------------------------------------------------------------------------------------------------------------------------------------------------------------|-------------------------------------|
| BC      | <b>VS - Checking the mechanical end stops</b><br>When enabled (ON), every time the power supply is connected the automation automatically checks the mechanical stops and/or stop limit switches during opening and closing at the speed set with the adjustment <b>AP</b> → <b>V</b> R.<br>During the learning operation, the display shows the message <b>MO</b> and the closing operation involves one gate wing at a time ( <b>1C</b> ). | <b>ON</b><br><b>OF</b>              |
|         | <b>CM - Motor circuit with automation idle</b><br><b>CL</b> - with the automation idle, the motor is kept in short-circuit<br><b>OP</b> - with the automation idle, the motor is kept open In the case of a reversible automation, set <b>CM</b> → <b>OP</b> to allow the motor to rotate freely.                                                                                                                                            | <b>CLOP</b><br>See paragraph 11.2.1 |

## 11.4 Second level menu - BA (Basic Adjustment)

| Display               | Description                                                                                                                                                                                                                       | Selections available                        |
|-----------------------|-----------------------------------------------------------------------------------------------------------------------------------------------------------------------------------------------------------------------------------|---------------------------------------------|
| BA - Basic adjustment | <b>TC - Setting of automatic closing time [s]</b><br>It is set with different intervals of sensitivity.<br>• from 0" to 59" with intervals of 1 second<br>• from 1' to 2' with intervals of 10 seconds                            | <b>0059</b><br><b>1' 2'</b><br><b>1'00"</b> |
|                       | <b>RP - Adjustment of partial opening measurement [%]</b><br>Adjusts the percentage of operation in relation to the total opening of the automation. Partial opening is performed on gate wing 1.<br>10 - Minimum<br>99 - Maximum | <b>1099</b><br><b>50</b>                    |
|                       | <b>TP - Setting of automatic closing time after partial opening [s]</b><br>It is set with different intervals of sensitivity.<br>• from 0" to 59" with intervals of 1 second<br>• from 1' to 2' with intervals of 10 seconds.     | <b>0059</b><br><b>1' 2'</b><br><b>30</b>    |
|                       | <b>VA - Opening speed [V]</b><br><b>NOTE:</b> MAX = 20 for:<br>LUX05BH<br>ARC1BH<br>DOR1BH<br>CUBIC6H-30H<br>BOX3SH<br>DOKE<br>POWER 50H                                                                                          | <b>0427</b><br>See paragraph 11.2.1         |
|                       | <b>VC - Closing speed [V]</b><br><b>NOTE:</b> MAX = 20 for:<br>LUX05BH<br>ARC1BH<br>DOR1BH<br>CUBIC6H-30H<br>BOX3SH<br>DOKE<br>POWER 50H                                                                                          | <b>0427</b><br>See paragraph 11.2.1         |

BA - Basic adjustment

| Display | Description                                                                                                                                                                                                                                                                                                                                                                                                                                                                                                                                                                                                                                                                                                                                                                                                                                                                                                                                                                    | Selections available                                                                                           |
|---------|--------------------------------------------------------------------------------------------------------------------------------------------------------------------------------------------------------------------------------------------------------------------------------------------------------------------------------------------------------------------------------------------------------------------------------------------------------------------------------------------------------------------------------------------------------------------------------------------------------------------------------------------------------------------------------------------------------------------------------------------------------------------------------------------------------------------------------------------------------------------------------------------------------------------------------------------------------------------------------|----------------------------------------------------------------------------------------------------------------|
| R 1     | <p><b>R1 - Adjustment of thrust on obstacles and current - motor 1 [%]</b><br/>                     The control panel is fitted with a safety device which, when it detects an obstacle:</p> <ul style="list-style-type: none"> <li>- stops the opening movement and, if outside the limit area for detecting obstacles, performs a disengagement operation whose duration can be set with <b>AP</b> → <b>DE</b> ;</li> <li>- reverses the movement during closure operations outside the limit area for detecting obstacles;</li> <li>- stops the movement during closure operations within the limit area for detecting obstacles.</li> </ul> <p>The limit area for detecting obstacles during opening and closing is determined by the type of limit switch installed. If there is no limit switch, it is determined on the basis of the selections <b>BA</b> → <b>00</b> and <b>BA</b> → <b>0C</b> .</p> <p><b>00</b> - Minimum thrust<br/> <b>99</b> - Maximum thrust</p> |  <p>See paragraph 11.2.1</p> |
| R 2     | <p><b>R2 - Adjustment of thrust on obstacles and current - motor 2 [%]</b><br/>                     The control panel is fitted with a safety device which, when it detects an obstacle:</p> <ul style="list-style-type: none"> <li>- stops the opening movement and, if outside the limit area for detecting obstacles, performs a disengagement operation whose duration can be set with <b>AP</b> → <b>DE</b> ;</li> <li>- reverses the movement during closure operations outside the limit area for detecting obstacles;</li> <li>- stops the movement during closure operations within the limit area for detecting obstacles.</li> </ul> <p>The limit area for detecting obstacles during opening and closing is determined by the type of limit switch installed. If there is no limit switch, it is determined on the basis of the selections <b>BA</b> → <b>00</b> and <b>BA</b> → <b>0C</b> .</p> <p><b>00</b> - Minimum thrust<br/> <b>99</b> - Maximum thrust</p> |  <p>See paragraph 11.2.1</p> |
| TR      | <p><b>TR - Motor delay time [s]</b><br/>                     Delay time for closure of gate wing 1 in relation to gate wing 2.<br/>                     00-30 s</p>                                                                                                                                                                                                                                                                                                                                                                                                                                                                                                                                                                                                                                                                                                                                                                                                            |                              |











**NOTE:** make adjustments gradually and only after performing at least three complete operations to allow the control panel to be set correctly and detect any friction during operations.

### 11.4.1 Additional BA level parameters that can be configured (available with **AT** → **AA** enabled)

| Display   | Description                                                                                                                                                                                                                                                                                                                                                                          | Selections available            |
|-----------|--------------------------------------------------------------------------------------------------------------------------------------------------------------------------------------------------------------------------------------------------------------------------------------------------------------------------------------------------------------------------------------|---------------------------------|
| <b>DT</b> | <b>DT - Adjustment of obstacle recognition time [s/100]</b><br>10 - Minimum<br>60 - Maximum<br><b>NOTE:</b> the parameter is adjusted in hundredths of a second.                                                                                                                                                                                                                     | 10 60<br>40                     |
| <b>ST</b> | <b>ST - Adjustment of start time [s]</b><br>0.5 - Minimum<br>3.0 - Maximum                                                                                                                                                                                                                                                                                                           | 0.5 3.0<br>2.0                  |
| <b>TA</b> | <b>TA - Adjustment of acceleration time during opening [s]</b><br>0.5 - Minimum<br>9.9 - Maximum                                                                                                                                                                                                                                                                                     | 0.5 9.9<br>See paragraph 11.2.1 |
| <b>TQ</b> | <b>TQ - Adjustment of acceleration time during closure [s]</b><br>0.5 - Minimum<br>9.9 - Maximum                                                                                                                                                                                                                                                                                     | 0.5 9.9<br>See paragraph 11.2.1 |
| <b>VM</b> | <b>VM - Initial movement speed [V]</b><br>00 - Minimum<br>15 - Maximum                                                                                                                                                                                                                                                                                                               | 00 20<br>See paragraph 11.2.1   |
| <b>TD</b> | <b>TD - Adjustment of deceleration time [%]</b><br>Adjusts the deceleration ramp slope<br>10 - Minimum<br>99 - Maximum                                                                                                                                                                                                                                                               | 10 99<br>50                     |
| <b>OB</b> | <b>OB - Setting of deceleration time during opening [s]</b><br>Indicates the time between the start of the deceleration ramp and the end of the opening stroke<br>00 - Minimum<br>30 - Maximum                                                                                                                                                                                       | 00 30<br>10                     |
| <b>CB</b> | <b>CB - Setting of deceleration time during closing [s]</b><br>Indicates the time between the start of the deceleration ramp and the end of the closing stroke<br>00 - Minimum<br>30 - Maximum                                                                                                                                                                                       | 00 30<br>10                     |
| <b>PO</b> | <b>PO - Adjustment of approach speed during opening [V]</b><br>Indicates the speed from the end of the deceleration ramp to the end of the opening stroke<br>03 - Minimum<br>10 - Maximum<br><b>NOTE:</b> gradually increase the approach speed if there is a series of quick vibrations (chattering) in heavy gates installed with a slight incline.                                | 03 10<br>See paragraph 11.2.1   |
| <b>PC</b> | <b>PC - Adjustment of approach speed during closing [V]</b><br>Indicates the speed from the end of the deceleration ramp to the end of the closing stroke.<br>03 - Minimum<br>10 - Maximum                                                                                                                                                                                           | 03 10<br>See paragraph 11.2.1   |
| <b>OO</b> | <b>OO - Obstacle detection limit during opening [%]</b><br>Indicates the percentage of the distance travelled during <b>BA</b> → <b>OB</b> or after the detection of the opening limit switch <b>AP</b> → <b>FA</b> → <b>RA</b> on which the disengagement is deactivated.<br><b>NOTE:</b> not active if <b>AP</b> → <b>FA</b> → <b>Sx</b> or if <b>AP</b> → <b>FA</b> → <b>Px</b> . | 05 99<br>99                     |
| <b>OC</b> | <b>OC - Obstacle detection limit during closure [%]</b><br>Indicates the percentage of the distance travelled during <b>BA</b> → <b>CB</b> or after the detection of the closing limit switch <b>AP</b> → <b>FC</b> → <b>RA</b> on which the reversal is deactivated.<br><b>NOTE:</b> not active if <b>AP</b> → <b>FC</b> → <b>Sx</b> and if <b>AP</b> → <b>FC</b> → <b>Px</b> .     | 05 99<br>99                     |

BA - Basic adjustment

BA - Basic adjustment

|           |                                                                                                                                                                                                                                                                                                                                                                                                                                                                                                                                                                                                                                                                                                                                                                                                                                                                                                                                                                                                                                |                                                                                    |
|-----------|--------------------------------------------------------------------------------------------------------------------------------------------------------------------------------------------------------------------------------------------------------------------------------------------------------------------------------------------------------------------------------------------------------------------------------------------------------------------------------------------------------------------------------------------------------------------------------------------------------------------------------------------------------------------------------------------------------------------------------------------------------------------------------------------------------------------------------------------------------------------------------------------------------------------------------------------------------------------------------------------------------------------------------|------------------------------------------------------------------------------------|
| <p>T0</p> | <p><b>T0 - Setting motor 2 opening delay time [s]</b><br/>Adjustment, in seconds, of the delay time for starting the operation of motor 2, in relation to motor 1.</p>                                                                                                                                                                                                                                                                                                                                                                                                                                                                                                                                                                                                                                                                                                                                                                                                                                                         |   |
| <p>LR</p> | <p><b>LR - Electric lock release time [s]</b><br/>If enabled, this indicates the electric lock activation time at the start of every opening operation with the automation closed.</p>                                                                                                                                                                                                                                                                                                                                                                                                                                                                                                                                                                                                                                                                                                                                                                                                                                         |  |
| <p>M1</p> | <p><b>M1 - Operation time - motor 1 [s]</b><br/>Adjustment, in seconds, of the total operation time for motor 1.<br/><b>i</b> <b>NOTE:</b> it is set with a sensitivity interval of 0.5s, shown when the decimal point on the right lights up.<br/>Example:  = 7 seconds /  = 7.5 seconds<br/><b>NOTE:</b> the setting of <b>M1</b> is only active with <b>BC</b> → <b>V5</b> → <b>OF</b>.</p>                                                                                                                                                                                                                                                                                                                                                                                                                                                               |  |
| <p>M2</p> | <p><b>M2 - Operation time - motor 2 [s]</b><br/>Adjustment, in seconds, of the total operation time for motor 1.<br/><b>i</b> <b>NOTE:</b> it is set with a sensitivity interval of 0.5s, shown when the decimal point on the right lights up.<br/>Example:  = 7 seconds /  = 7.5 seconds<br/><b>NOTE:</b> the setting of <b>M2</b> is only active with <b>BC</b> → <b>V5</b> → <b>OF</b>.</p>                                                                                                                                                                                                                                                                                                                                                                                                                                                               |  |
| <p>EO</p> | <p><b>EO - Function of output -LK+</b><br/> <b>00</b> - courtesy light<br/> <b>01</b> - electric lock (12V-)<br/> <b>02</b> - electric lock + release stroke (12V-)<br/> <b>03</b> - output active with automation closed (for electromagnets of the fail-safe type)<br/> <b>04</b> - output active with automation open<br/> <b>05</b> - output active with automation moving (can also be used for electromagnets that need to be powered throughout the operation)<br/> <b>06</b> - output active with automation opening<br/> <b>07</b> - output active with automation closing<br/> <b>08</b> - output active with maintenance alarm triggered<br/> <b>09</b> - output active for indicating batteries almost flat<br/> <b>10</b> - ON-OFF flashing light for LED without oscillator<br/> <b>11</b> - ON-OFF flashing light<br/> <b>ON</b> - output always active</p>                                                                                                                                                     |                                                                                    |
| <p>FF</p> | <p><b>FF - Function of output +LP-</b><br/> <b>00</b> - courtesy light<br/> <b>01</b> - ON-OFF flashing light<br/> <b>02</b> - fixed light with internal oscillator<br/> <b>03</b> - output active with automation closed<br/> <b>04</b> - output active with automation open<br/> <b>05</b> - output active with automation moving<br/> <b>06</b> - output active with automation opening<br/> <b>07</b> - output active with automation closing<br/> <b>08</b> - output active with maintenance alarm triggered<br/> <b>09</b> - output active for indicating batteries almost flat<br/> <b>10</b> - ON-OFF flashing light for LED without oscillator<br/> <b>11</b> - electric lock (12V-)<br/> <b>12</b> - electric lock + release stroke (12V-)<br/> <b>13</b> - electric lock with DC drive<br/> <b>14</b> - electric lock with release stroke with DC drive<br/> <b>ON</b> - output always active<br/> <b>i</b> <b>NOTE:</b> with FF 13 or 14, a 10Q 20W resistor must be inserted in series with the electric lock</p> |                                                                                    |

| Display                          | Description                                                                                                                                                                                                    |
|----------------------------------|----------------------------------------------------------------------------------------------------------------------------------------------------------------------------------------------------------------|
| BA<br><br><b>OL</b>              | <b>OL - Indicator light for automation open</b>                                                                                                                                                                |
|                                  | <b>00</b> - proportional flashing depending on the point where the gate wings are positioned and the operation direction (in battery mode, the flashing is different)                                          |
|                                  | <b>01</b> - fixed ON (automation not closed)                                                                                                                                                                   |
|                                  | <b>02</b> - output active with automation not open                                                                                                                                                             |
|                                  | <b>03</b> - output active with automation closed                                                                                                                                                               |
|                                  | <b>04</b> - output active with automation open                                                                                                                                                                 |
|                                  | <b>05</b> - output active with automation moving                                                                                                                                                               |
|                                  | <b>06</b> - output active with automation opening                                                                                                                                                              |
|                                  | <b>07</b> - output active with automation closing                                                                                                                                                              |
|                                  | <b>08</b> - output active with maintenance alarm triggered                                                                                                                                                     |
|                                  | <b>09</b> - output active for indicating batteries almost flat                                                                                                                                                 |
|                                  | <b>10</b> - Recommended functionality for PWR50HR motor: Connect a relay with 24V= coil with 250V 16A contact to disconnect the motors when the automation is stopped. Connection diagram in the motor manual. |
| <b>ON</b> - output always active |                                                                                                                                                                                                                |

**NOTE:** make adjustments gradually and only after performing at least three complete operations to allow the control panel to be set correctly and detect any friction during operations.

## 11.5 Second level menu - RO (Radio Operations)

| Display                                | Description                                                                                                                                                                                                                                                                                                                                                         |
|----------------------------------------|---------------------------------------------------------------------------------------------------------------------------------------------------------------------------------------------------------------------------------------------------------------------------------------------------------------------------------------------------------------------|
| RO - Radio operations<br><br><b>SR</b> | <b>SR - Remote control storage</b><br>You can directly access the Remote control storage menu even with the display turned off, but only with the Display visualisation mode option set to 00 or 03:<br>- for transmitting a remote control not present in the memory;<br>- for transmitting an unstored channel of a remote control already present in the memory. |
|                                        |                                                                                                                                                                                                                                                                                                                                                                     |
|                                        | <b>WARNING:</b> if the display shows <b>NO</b> flashing, the remote control may already be stored.                                                                                                                                                                                                                                                                  |
| <b>TX</b>                              | <b>TX - Visualisation of counter showing remote controls stored</b><br>ENTER → <b>00</b> → <b>16</b> → 16 remote controls (example)                                                                                                                                                                                                                                 |
| <b>MU</b>                              | <b>MU - Indication of maximum number of remote controls that can be stored in the integrated memory</b><br>You can store a maximum of 100 or 200 remote control codes.                                                                                                                                                                                              |
|                                        | ENTER → <b>10</b> or <b>20</b> → ENTER → <b>OK</b><br>20 - 200 remote controls that can be stored<br>10 - 100 remote controls that can be stored                                                                                                                                                                                                                    |
|                                        | <b>Selections available</b><br><b>20 10</b>                                                                                                                                                                                                                                                                                                                         |





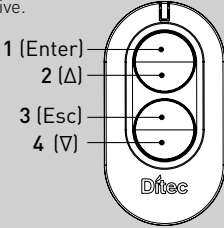

**WARNING:** selecting **MU** → **20** (200 remote controls), the configurations **U 1** and **U 2** saved with the **SF** → **SV** command will be lost. This also applies for the last configuration reloaded with **RL**. In addition, new configurations cannot be saved on **U 1** and **U 2**.

| Display   | Description                                                                                                                                                                                                                                                                                                                                                                                                                                                                                                                                                                                                                                                                                                                                                                                                                                                                                                                                                                                                                                                                                                                                                                                                                                                                                           | Selections available            |
|-----------|-------------------------------------------------------------------------------------------------------------------------------------------------------------------------------------------------------------------------------------------------------------------------------------------------------------------------------------------------------------------------------------------------------------------------------------------------------------------------------------------------------------------------------------------------------------------------------------------------------------------------------------------------------------------------------------------------------------------------------------------------------------------------------------------------------------------------------------------------------------------------------------------------------------------------------------------------------------------------------------------------------------------------------------------------------------------------------------------------------------------------------------------------------------------------------------------------------------------------------------------------------------------------------------------------------|---------------------------------|
| <b>RK</b> | <p><b>RK</b> - Menu navigation using remote control keyboard<br/> <b>ON</b> - Enabled<br/> <b>OF</b> - Disabled</p> <p>With the display turned off, quickly type in the sequence of keys ③ ③ ② ④ ① from the stored remote control you want to use.<br/>           Make sure all the CH keys are stored.<br/> <b>WARNING:</b> during navigation with a remote control keyboard ALL the stored remote controls are inactive.</p>  <p>1 (Enter)<br/>           2 (Δ)<br/>           3 (Esc)<br/>           4 (∇)</p> <p>Ditec</p> <p>To make viewing and adjustment easier (avoiding the need to continuously press the remote control), press the UP ↑ or DOWN ↓ key once to begin slowly scrolling through the parameters.<br/>           This scrolling movement is faster if the UP ↑ or DOWN ↓ key is pressed twice.<br/>           To stop the scrolling, press ENTER.<br/>           To confirm your choice of parameter, press ENTER again.<br/>           To test any new setting, switch off the display and issue an opening command using key ③.<br/>           Navigation using a remote control keyboard is automatically disabled after 4 minutes of inactivity or by setting <b>RK</b> → <b>OF</b>.</p> | <p><b>ON</b><br/> <b>OF</b></p> |

11.5.1 Additional R0 level parameters that can be configured (available with **AT** → **AA** enabled)

| Display      | Description                                                                                                                                                                                                                                                                                                                                                                                                                                                                                                                                                                                                                                                                                                                                                                                                                                                                                                                                                                                                                          | Selections available                                                                                           |
|--------------|--------------------------------------------------------------------------------------------------------------------------------------------------------------------------------------------------------------------------------------------------------------------------------------------------------------------------------------------------------------------------------------------------------------------------------------------------------------------------------------------------------------------------------------------------------------------------------------------------------------------------------------------------------------------------------------------------------------------------------------------------------------------------------------------------------------------------------------------------------------------------------------------------------------------------------------------------------------------------------------------------------------------------------------|----------------------------------------------------------------------------------------------------------------|
| <b>[ 1 ]</b> | <p><b>C1, C2, C3, C4</b> - Selection of CH1, CH2, CH3, CH4 function of stored remote control.<br/> <b>NO</b> - No setting selected<br/> <b>1-3</b> - Opening command<br/> <b>1-4</b> - Closing command<br/> <b>1-5</b> - Step-by-step command<br/> <b>P3</b> - Partial opening command<br/> <b>LG</b> - Command to switch the courtesy light on/off<br/> <b>1-9</b> - STOP command</p> <p>If even just one (any) CH key of the remote control is stored, the opening or step-by-step command is implemented.<br/> <b>NOTE:</b> the <b>1-3</b> (opening) and <b>1-5</b> (step-by-step) options are available as alternatives, and depend on the selection <b>BC</b> → <b>RM</b>.</p> <p>If 2-4 CH keys of a single remote control are stored, the functions matched in the factory with the CH keys are as follows:</p> <ul style="list-style-type: none"> <li>• CH1 = opening/step-by-step command</li> <li>• CH2 = partial opening command;</li> <li>• CH3 =courtesy light on/off command</li> <li>• CH4 = STOP command.</li> </ul> | <p><b>NO</b><br/> <b>1-3</b><br/> <b>1-4</b><br/> <b>1-5</b><br/> <b>P3</b><br/> <b>LG</b><br/> <b>1-9</b></p> |
| <b>[ 2 ]</b> |                                                                                                                                                                                                                                                                                                                                                                                                                                                                                                                                                                                                                                                                                                                                                                                                                                                                                                                                                                                                                                      |                                                                                                                |
| <b>[ 3 ]</b> |                                                                                                                                                                                                                                                                                                                                                                                                                                                                                                                                                                                                                                                                                                                                                                                                                                                                                                                                                                                                                                      |                                                                                                                |
| <b>[ 4 ]</b> |                                                                                                                                                                                                                                                                                                                                                                                                                                                                                                                                                                                                                                                                                                                                                                                                                                                                                                                                                                                                                                      |                                                                                                                |





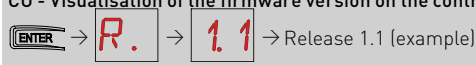
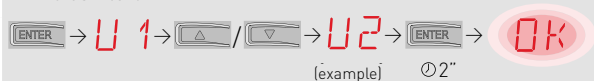
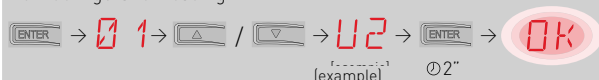

| Display               | Description                                                                                                                                                                                                                                                                                                                                                                                                                                                                                                                                         | Selections available |
|-----------------------|-----------------------------------------------------------------------------------------------------------------------------------------------------------------------------------------------------------------------------------------------------------------------------------------------------------------------------------------------------------------------------------------------------------------------------------------------------------------------------------------------------------------------------------------------------|----------------------|
| RO - Radio operations | ER - Deletion of a single remote control<br><br>02"                                                                                                                                                                                                                                                                                                                                                                                                                |                      |
|                       | EA - Total memory deletion<br><br>02"                                                                                                                                                                                                                                                                                                                                                                                                                              |                      |
|                       | RE - Setting memory opening from remote control<br>OF - Disabled<br>ON - Enabled When enabled (ON), the remote programming is activated.<br>To store new remote controls without using the control panel, refer to the remote control instructions.<br><b>NOTE:</b> make sure you do not accidentally memorise unwanted remote controls.                                                                                                                                                                                                            | ON<br>OF             |
|                       | EP - Setting the coded area messages<br>If the possibility to receive coded messages is enabled, the control panel will be compatible with remote controls of the "ENCRYPTED" type.                                                                                                                                                                                                                                                                                                                                                                 | ON<br>OF             |
|                       | MS - Backward compatibility setting with older generation GOL4 remote controls.<br> <b>NOTE:</b> firmware version 1.6.5 or higher is required.<br>OF - Compatibility with old generation GOL4 and new ZEN remote controls.<br>ON - Compatibility with ZEN series remote controls<br> <b>NOTE:</b> MS=ON is recommended if only ZEN series remote controls are used on the system. | OF<br>ON             |

## 11.6 Second level menu - SF (Special Functions)

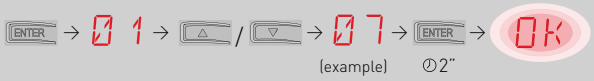
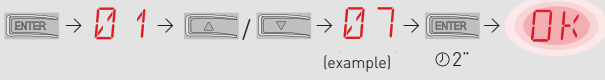
| Display                | Description                                                                                                                                                                                  | Selections available     |
|------------------------|----------------------------------------------------------------------------------------------------------------------------------------------------------------------------------------------|--------------------------|
| SF - Special functions | CU - Visualisation of the firmware version on the control panel<br>                                         |                          |
|                        | SV - Saving user configuration on control panel storage module and/or on microSD card<br><br>(example) 02" | U 1<br>U 2<br>D 1<br>D 2 |
|                        | RC - Configuration loading<br><br>(example) 02"                                                           | U 1<br>U 2<br>D 1<br>D 2 |

| Display                | Description                                                                                                                                                                                                                                                                                                                                                                                                                                                                                                  |
|------------------------|--------------------------------------------------------------------------------------------------------------------------------------------------------------------------------------------------------------------------------------------------------------------------------------------------------------------------------------------------------------------------------------------------------------------------------------------------------------------------------------------------------------|
| <b>SF</b><br><b>RL</b> | <b>RL - Loading of last configuration set</b><br><br>⌀2" <p>The control panel automatically saves the last configuration set, and keeps it memorised in the storage module or microSD card.</p> <p>In the event of a fault or the replacement of the control panel, the last configuration of the automation can be restored by inserting the storage module or microSD card and loading the configuration in question.</p> |

### 11.6.1 Additional SF level parameters that can be configured (available with **AT** → **AA** enabled)

| Display                                    | Description                                                                                                                                                                                                                                                                                                                                                                                                                                                                                                            |
|--------------------------------------------|------------------------------------------------------------------------------------------------------------------------------------------------------------------------------------------------------------------------------------------------------------------------------------------------------------------------------------------------------------------------------------------------------------------------------------------------------------------------------------------------------------------------|
| <b>SF - Special functions</b><br><b>SP</b> | <b>SP - Setting the password</b><br><br>[example] ⌀2" <p><b>NOTE:</b> this can only be selected when the password is not set.</p> <p>Setting the password prevents unauthorised personnel from accessing selections and adjustments.</p> <p>You can delete the set password by selecting the sequence JR1=ON, JR1=OFF, JR1=ON.</p>                                                                                                    |
| <b>IP</b>                                  | <b>IP - Inserting the password</b><br><br>[example] ⌀2" <p><b>NOTE:</b> this can only be selected when the password is set.</p> <p>When the password is not inserted, you can access the display mode regardless of the selection made with JR1.</p> <p>When the password is inserted, you can access in maintenance mode.</p>                                                                                                        |
| <b>EU</b>                                  | <b>EU - Deletion of user configurations and last configuration set in the storage module</b><br><br>⌀2"                                                                                                                                                                                                                                                                                                                              |
| <b>AL</b>                                  | <b>AL - Alarm counter</b><br>Used to view, in sequence, the counters of alarms that have been triggered at least once (alarm code + number of times triggered).<br>With  and  , you can scroll through all the counters and see all the alarms recorded.                                                                                         |
| <b>AH</b>                                  | <b>AH - Alarm log</b><br>Used to view, in sequence, alarms that have been triggered (maximum 20).<br>With  and  , you can scroll through the entire alarm log.<br>The display shows the alarm number and code, alternated.<br>The highest number corresponds to the most recent alarm and the lowest number (0) corresponds to the oldest alarm. |

SF - Special functions

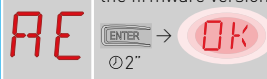
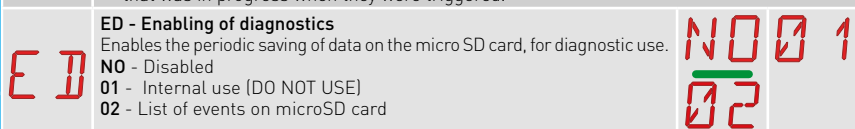
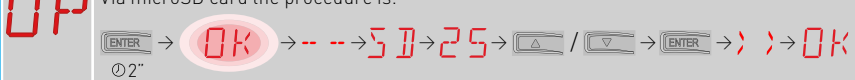
| Display                                                                                                                                                                                                                                                                                                                               | Description                                                                                                                                         |
|---------------------------------------------------------------------------------------------------------------------------------------------------------------------------------------------------------------------------------------------------------------------------------------------------------------------------------------|-----------------------------------------------------------------------------------------------------------------------------------------------------|
| <p><b>AR - Alarm reset</b><br/>Resets all the alarms in the memory (counters and log).</p>                                                                                                                                                           | <p><b>NOTE:</b> when the installation has been completed, you are advised to delete the alarms in order to facilitate future checks.</p>            |
| <p><b>AE - Writing of alarms on microSD card</b><br/>Creates a text file on the microSD memory, containing some information about the control panel: the firmware version, operation counters, hour counters, configuration parameters, alarms.</p>  | <p><b>NOTE:</b> the alarm counters and alarm log are associated with the number of the operation that was in progress when they were triggered.</p> |
| <p><b>ED - Enabling of diagnostics</b><br/>Enables the periodic saving of data on the micro SD card, for diagnostic use.</p> <p><b>NO</b> - Disabled<br/><b>01</b> - Internal use [DO NOT USE]<br/><b>02</b> - List of events on microSD card</p>    |                                                                                                                                                     |
| <p><b>SU - Safe removal of the microSD card</b></p>                                                                                                                                                                                                                                                                                   |                                                                                                                                                     |
| <p><b>IM - Motor current visualisation</b><br/>Selecting <b>M 1</b>, the display will show the current absorbed by motor 1.<br/>Selecting <b>M 2</b>, the display will show the current absorbed by motor 2.</p>                                                                                                                      |                                                                                                                                                     |
| <p><b>UP - Firmware update</b><br/>The FW update can be carried out using USBPROG (possible from card version 2.4).<br/>Via microSD card the procedure is:</p>                                                                                       |                                                                                                                                                     |

### 11.7 Second level menu - CC (Cycles Counter)

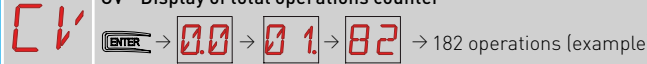
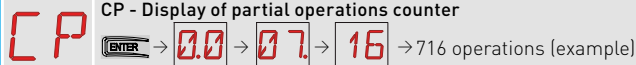
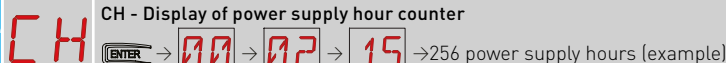
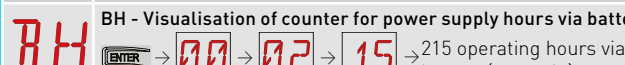
| Display                                                                                                                                                            | Description                                        |
|--------------------------------------------------------------------------------------------------------------------------------------------------------------------|----------------------------------------------------|
| <p><b>CV - Display of total operations counter</b></p>                          | <p>→ 182 operations (example)</p>                  |
| <p><b>CP - Display of partial operations counter</b></p>                        | <p>→ 716 operations (example)</p>                  |
| <p><b>CH - Display of power supply hour counter</b></p>                         | <p>→ 256 power supply hours (example)</p>          |
| <p><b>BH - Visualisation of counter for power supply hours via battery</b></p>  | <p>→ 215 operating hours via battery (example)</p> |

### 11.7.1 Additional CC level parameters that can be configured (available with **AT** → **AA** enabled)

| Display             | Description                                                                                                                                                                                                                                                                                                                                                                                                                                           | Selections available |
|---------------------|-------------------------------------------------------------------------------------------------------------------------------------------------------------------------------------------------------------------------------------------------------------------------------------------------------------------------------------------------------------------------------------------------------------------------------------------------------|----------------------|
| CC - Cycles counter | <b>CA - Setting the maintenance alarm (factory setting - alarm deactivated: 0.0 00. 00).</b><br>You can set the required number of operations (regarding the partial operations counter) for signalling the maintenance alarm.<br>When the set number of operations is reached, the alarm message appears on the display .<br>Example:<br>Setting the maintenance alarm after 700 operations (00) (07) (00)<br>                                       |                      |
|                     | <b>OA - Selecting maintenance alarm display mode</b><br><b>00</b> - Visualisation on display (alarm message ).<br><b>01</b> - Visualisation on flashing light (with the automation idle, 4 flashes are made and then repeated every hour) and on display (alarm message ).<br><b>02</b> - Visualisation on "open gate" indicator light (with the automation closed, 4 flashes are made and then repeated every hour) and on display (alarm message ). | <br><br>             |
|                     | <b>ZP - Reset of partial operations counter</b><br><br>For correct functioning, you are advised to reset the partial operations counter:<br>- after maintenance work;<br>- after setting the maintenance alarm interval.                                                                                                                                                                                                                              |                      |

### 11.8 Second level menu - EM (Energy Management)

| Display                | Description                                                                                                                                                                                                                                                                                                                                                                                                                                                                                                                                                                                                                                                                                                                                                                                                                         | Selections available |
|------------------------|-------------------------------------------------------------------------------------------------------------------------------------------------------------------------------------------------------------------------------------------------------------------------------------------------------------------------------------------------------------------------------------------------------------------------------------------------------------------------------------------------------------------------------------------------------------------------------------------------------------------------------------------------------------------------------------------------------------------------------------------------------------------------------------------------------------------------------------|----------------------|
| EM - Energy management | <b>PV - Solar panel power supply (panels not supplied)</b><br><b>ON</b> - Enabled<br><b>OF</b> - Disabled                                                                                                                                                                                                                                                                                                                                                                                                                                                                                                                                                                                                                                                                                                                           | <br>                 |
|                        | <b>ES - "Green Mode" (energy-saving) (disconnection of accessories connected to terminals 0-1 when the automation is in standby)</b><br><b>ON</b> - Enabled (the red point on the right of the display flashes every 5s. Outputs +LP-, -LK+ and 30-13 are not managed in low-consumption mode)<br><b>OF</b> - Disabled<br>Power supply disconnection mode is activated after 15 s with the gate closed, or when the gate is idle and automatic closure is not enabled.<br>The automation resumes its normal operation when a command is received on the radio board (ZENRS-ZENPRS) or following a contact 30-5, 30-20, 30-3 or 30-4.<br><b>WARNING:</b> if you use accessories that need to remain powered even with Green Mode enabled (e.g. LAN4 or GOPAV), set the jumper AUX1-2 relating to the slot used on power supply 0-30. | <br>                 |

### 11.8.1 Additional EM level parameters that can be configured (available with **AT** → **AA** enabled)

| Display                | Description                                                                                                                                                                                                                                                                                                                                                                                                                                                  | Selections available |
|------------------------|--------------------------------------------------------------------------------------------------------------------------------------------------------------------------------------------------------------------------------------------------------------------------------------------------------------------------------------------------------------------------------------------------------------------------------------------------------------|----------------------|
| EM - Energy management | <b>LL - Voltage threshold for indicating that batteries are almost flat [V]</b><br>17 - Minimum<br>24 - Maximum<br><b>NOTE:</b> it is set with an interval of sensitivity of 0.5V shown when the decimal point on the right lights up.                                                                                                                                                                                                                       |                      |
|                        | <b>LB - Indication that batteries are almost flat</b><br>00 - Visualisation on display (alarm message <b>BQ</b> )<br>01 - Visualisation on flashing light (with the automation idle, 2 flashes are made and then repeated every hour) and on display (alarm message <b>BQ</b> )<br>02 - Visualisation on "open gate" indicator light (with the automation closed, 2 flashes are made and then repeated every hour) and on display (alarm message <b>BQ</b> ) |                      |
|                        | <b>BT - Battery mode</b><br>00 - Anti-panic (performs the opening operation following a mains supply failure. The automation opens but does not accept any other commands until the mains supply has been restored).<br>01 - Continuous operation - the last operation performed before control panel switch-off will be an opening.<br>02 - Continuous operation - the last operation performed before control panel switch-off will be an closure.         |                      |

### 11.9 Second level menu - AP (Advanced Parameters)

| Display                  | Description                                                                                                                                                                                                                                                                                                                                                                                       | Selections available |
|--------------------------|---------------------------------------------------------------------------------------------------------------------------------------------------------------------------------------------------------------------------------------------------------------------------------------------------------------------------------------------------------------------------------------------------|----------------------|
| AP - Advanced parameters | <b>FA - Selection of opening limit switch mode</b><br>NO - None<br>SX - Stop limit switch (after activation, the gate wing stops its movement)<br>PX - Proximity limit switch (after activation, the gate wing continues as far as the end stop and any obstacle is considered a stop)<br>RA - Deceleration limit switch (after activation, the gate wing slows down its movement)                |                      |
|                          | <b>FC - Selection of closing limit switch mode</b><br>NO - None<br>SX - Stop limit switch (after activation, the gate wing stops its movement)<br>PX - Proximity limit switch (after activation, the gate wing continues as far as the end stop and any obstacle is considered a stop)<br>RA - Deceleration limit switch (after activation, the gate wing slows down its movement)                |                      |
|                          | <b>D6 - Selection of device connected to terminals 1-6</b><br>NO - None<br>SE - Safety edge (if contact 1-6 opens, there is a disengagement of 10cm after the stop)<br>S41 - Safety edge with safety test (if contact 1-6 opens, after the stop there is a disengagement of a duration depending on the selection <b>AP</b> → <b>DE</b> )<br>PH - Photocells<br>P41 - Photocells with safety test |                      |

AP - Advanced parameters

| Display   | Description                                                                                                                                                                                                                                                                                                                                                                                                                             | Selections available   |
|-----------|-----------------------------------------------------------------------------------------------------------------------------------------------------------------------------------------------------------------------------------------------------------------------------------------------------------------------------------------------------------------------------------------------------------------------------------------|------------------------|
| <b>D8</b> | <b>D8 - Selection of device connected to terminals 1-8</b><br>NO - None<br>SE - Safety edge<br>S41 - Safety edge with safety test<br>PH - Photocells<br>P41 - Photocells with safety test                                                                                                                                                                                                                                               | NO SE<br>S41 PH<br>P41 |
| <b>R9</b> | <b>R9 - Configuration of input 30-9</b><br>NO - Disabled<br>9P - The opening of the input causes a permanent stop<br>9T - The opening of the input causes a temporary stop. When the contact closes, the automatic closure time is activated (if enabled)<br>HR - With the input open, the automation operates in "operator present" mode                                                                                               | NO 9T<br>9P HR         |
| <b>68</b> | <b>68 - Selection of the device simultaneously connected to terminals 1-6 and 1-8</b><br>NO - None<br>SE - Safety edge<br>S41 - Safety edge with safety test<br>If different from NO, the simultaneous opening of inputs 1-6 and 1-8 causes:<br>- movement stop and reversal during a closing operation<br>- movement stop and disengagement of a duration depending on the selection <b>AP</b> → <b>DE</b> during an opening operation | NO<br>SE<br>S41        |
| <b>D5</b> | <b>D5 - Setting of display visualisation mode</b><br>00 - No visualisation<br>01 - Commands and safety devices with radio test. Display of count-down to automatic closing<br>02 - Automation status (see paragraph 13.1)<br>03 - Commands and safety devices (see paragraph 13.2)<br><b>NOTE:</b> the setting <b>D 1</b> allows you to see when a radio transmission is received, for range checks.                                    | 00<br>01<br>02<br>03   |

**i** **NOTE:** make adjustments gradually and only after performing at least three complete operations to allow the control panel to be set correctly and detect any friction during operations.

11.9.1 Additional AP level parameters that can be configured  
(available with **AT** → **AA** enabled)

| Display                                                                                                                        | Description                                                                                                                                                                                                                                                                                                                                                                                                                                                                                                                                                                                                                                                        | Selections available                                                     |
|--------------------------------------------------------------------------------------------------------------------------------|--------------------------------------------------------------------------------------------------------------------------------------------------------------------------------------------------------------------------------------------------------------------------------------------------------------------------------------------------------------------------------------------------------------------------------------------------------------------------------------------------------------------------------------------------------------------------------------------------------------------------------------------------------------------|--------------------------------------------------------------------------|
| AP - Advanced parameters<br><br><b>LU</b><br><br><b>LG</b><br><br><b>PT</b><br><br><b>DE</b><br><br><b>DO</b><br><br><b>DC</b> | <b>LU - Setting the courtesy light switch-on time [s]</b><br>To enable this parameter, set at least one of the selections <b>BA</b> → <b>E0</b> or <b>BA</b> → <b>FF</b> as a courtesy light.<br>It is set with different intervals of sensitivity.<br><b>NO</b> - Disabled<br>- from 01" to 59" with intervals of 1 second<br>- from 1' to 2' with intervals of 10 seconds<br>- from 2' to 3' with intervals of 1 minute<br><b>ON</b> - Permanently enabled (switched off via remote control)<br><b>NOTE:</b> the courtesy light switches on at the start of each operation.                                                                                      | <b>NO</b><br><b>0 1 5 9</b><br><b>1' 2'</b><br><b>2' 3'</b><br><b>ON</b> |
|                                                                                                                                | <b>LG - Switch-on time for independently commanded courtesy light [s]</b><br>To enable this parameter, set at least one of the selections <b>BA</b> → <b>E0</b> or <b>BA</b> → <b>FF</b> as a courtesy light.<br>It is set with different intervals of sensitivity.<br><b>NO</b> - Disabled<br>- from 01" to 59" with intervals of 1 second<br>- from 1' to 2' with intervals of 10 seconds<br>- from 2' to 3' with intervals of 1 minute<br><b>ON</b> - Switched on and off with remote control<br><b>NOTE:</b> the switching on of the light does not depend on the start of an operation, but can be commanded separately using the special remote control key. | <b>NO</b><br><b>0 1 5 9</b><br><b>1' 2'</b><br><b>2' 3'</b><br><b>ON</b> |
|                                                                                                                                | <b>PT - Fixed partial opening</b><br><b>ON</b> - Enabled<br><b>OF</b> - Disabled<br>If <b>ON</b> , a partial opening command given on the partial opening position is ignored.<br>With contact 30-20 closed (for example with the timer or manual selector), the gate will partially open. If it is then fully opened (command 30-3) and reclosed (even with automatic closing), it will stop at the partial opening position.                                                                                                                                                                                                                                     | <b>ON OF</b>                                                             |
|                                                                                                                                | <b>DE - Disengagement duration if an edge is triggered [s]</b><br>Regulates the duration of the disengagement when an edge (active or passive) is triggered during opening or closure.<br>In the case of gates with two wings, it acts on both wings.<br><b>00</b> - Deactivated                                                                                                                                                                                                                                                                                                                                                                                   | <b>0.0 2.0</b><br><b>1.0</b>                                             |
|                                                                                                                                | <b>DO - Duration of disengagement on stop during opening [s/100]</b><br>Regulates the duration of the disengagement on the mechanical opening stop.<br><b>00</b> - Disabled<br><b>99</b> - Maximum<br><b>NOTE:</b> not active if <b>FA</b> → <b>SX</b>                                                                                                                                                                                                                                                                                                                                                                                                             | <b>00 99</b>                                                             |
|                                                                                                                                | <b>DC - Duration of disengagement on stop during closure [s/100]</b><br>Regulates the duration of the disengagement on the mechanical opening stop.<br><b>00</b> - Disabled<br><b>99</b> - Maximum<br><b>NOTE:</b> not active if <b>FC</b> → <b>SX</b>                                                                                                                                                                                                                                                                                                                                                                                                             | <b>00 99</b>                                                             |

AP - Advanced parameters

| Display   | Description                                                                                                                                                                                                                                                                                                                                                                                                                                                                                                                                                                                                                                                                                                                                                                                                                                                                                                                                                                                                                                                                                                                                                                                                                                                                                                                                                                                                                                                                                                                                                                                                                                       | Selections available           |
|-----------|---------------------------------------------------------------------------------------------------------------------------------------------------------------------------------------------------------------------------------------------------------------------------------------------------------------------------------------------------------------------------------------------------------------------------------------------------------------------------------------------------------------------------------------------------------------------------------------------------------------------------------------------------------------------------------------------------------------------------------------------------------------------------------------------------------------------------------------------------------------------------------------------------------------------------------------------------------------------------------------------------------------------------------------------------------------------------------------------------------------------------------------------------------------------------------------------------------------------------------------------------------------------------------------------------------------------------------------------------------------------------------------------------------------------------------------------------------------------------------------------------------------------------------------------------------------------------------------------------------------------------------------------------|--------------------------------|
| <b>OT</b> | <b>OT - Selection of type of obstacle</b><br>00 - Overcurrent or gate stopped<br>01 - Overcurrent<br>02 - Door stopped                                                                                                                                                                                                                                                                                                                                                                                                                                                                                                                                                                                                                                                                                                                                                                                                                                                                                                                                                                                                                                                                                                                                                                                                                                                                                                                                                                                                                                                                                                                            | 00 01<br>02 <u>0</u>           |
| <b>CR</b> | <b>CR - Stroke estimate correction [%]</b><br>DO NOT USE [diagnostic purposes only]                                                                                                                                                                                                                                                                                                                                                                                                                                                                                                                                                                                                                                                                                                                                                                                                                                                                                                                                                                                                                                                                                                                                                                                                                                                                                                                                                                                                                                                                                                                                                               | -- 9 + 9                       |
| <b>SM</b> | <b>SM - Selection of operating mode of device connected to terminals 1-6</b><br>00 - During the operation, the opening of the safety contact stops the movement (with disengagement if <b>DB</b> → <b>SE / S4</b> ).<br>01 - During the operation, the opening of the safety contact stops the movement (with disengagement if <b>DB</b> → <b>SE / S4</b> ). When the contact closes again, the interrupted operation is resumed.<br>02 - During the operation, the opening of the safety contact stops the movement (with disengagement if <b>DB</b> → <b>SE / S4</b> ). When the contact closes again, an opening operation is performed.<br>03 - During the closing operation, the opening of the safety contact reverses the movement. During the opening operation, the safety device is ignored.<br>04 - During the opening operation, the opening of the safety contact stops the movement (with disengagement if <b>DB</b> → <b>SE / S4</b> ). When the contact closes again, the interrupted opening operation is resumed. During the closing operation, the safety device is ignored.<br>05 - During the closing operation, the opening of the safety contact stops and reverses the movement. During the opening operation, the opening of the safety contact stops the movement (with disengagement if <b>DB</b> → <b>SE / S4</b> ).<br><b>WARNING:</b> if, when contact 1-6 closes, the safety contact 1-8 is open, the automation will not operate. When contact 1-8 is subsequently closed, the control panel will perform an automatic closing and will not execute the opening. To avoid the above situation, set <b>S0 = OF</b> | 00 01<br><u>02</u> 03<br>04 05 |
| <b>TN</b> | <b>TN - Setting of intervention temperature for NIO electronic anti-freeze system and automatic HS ramps [°C]</b><br>This value does not refer to the ambient temperature, but to the internal control panel temperature.                                                                                                                                                                                                                                                                                                                                                                                                                                                                                                                                                                                                                                                                                                                                                                                                                                                                                                                                                                                                                                                                                                                                                                                                                                                                                                                                                                                                                         | -- 9 <u>50</u>                 |
| <b>HS</b> | <b>HS - Automatic ramp adjustment</b><br>ON - Enabled<br>OF - Disabled<br>When enabled (ON), at low ambient temperatures the start time <b>ST</b> increases up to the maximum value and the acceleration time <b>TA</b> and <b>TQ</b> diminishes to the minimum value.<br><b>NOTE:</b> for correct operation, the control panel must be exposed to the same ambient temperature as the motors.<br>The intervention temperature can be set via the selection <b>AP</b> → <b>TN</b> .                                                                                                                                                                                                                                                                                                                                                                                                                                                                                                                                                                                                                                                                                                                                                                                                                                                                                                                                                                                                                                                                                                                                                               | ON<br><u>OF</u>                |
| <b>TB</b> | <b>TB - Permanent display of the internal control panel temperature [°C]</b>                                                                                                                                                                                                                                                                                                                                                                                                                                                                                                                                                                                                                                                                                                                                                                                                                                                                                                                                                                                                                                                                                                                                                                                                                                                                                                                                                                                                                                                                                                                                                                      | ON <u>OF</u>                   |
| <b>WO</b> | <b>WO - Setting of pre-flashing time on opening [s]</b><br>Adjustment of the lead time for the switch-on of the flashing light, in relation to the start of the opening operation from a voluntary command.<br>00 - Minimum<br>05 - Maximum                                                                                                                                                                                                                                                                                                                                                                                                                                                                                                                                                                                                                                                                                                                                                                                                                                                                                                                                                                                                                                                                                                                                                                                                                                                                                                                                                                                                       | 00 05<br><u>00</u>             |

| Display                                    | Description                                                                                                                                                                                                                                 | Selections available         |
|--------------------------------------------|---------------------------------------------------------------------------------------------------------------------------------------------------------------------------------------------------------------------------------------------|------------------------------|
| AP - Advanced parameters<br>WC<br>TS<br>VR | <b>WC - Setting of pre-flashing time on closing [s]</b><br>Adjustment of the lead time for the switch-on of the flashing light, in relation to the start of the closing operation from a voluntary command.<br>00 - Minimum<br>05 - Maximum | 0005<br>00''                 |
|                                            | <b>TS - Setting of renewal of automatic closing time after safety device release [%]</b><br>00 - Minimum<br>99 - Maximum                                                                                                                    | 0099<br>99                   |
|                                            | <b>VR - Setting of learning speed [V]</b>                                                                                                                                                                                                   | 0420<br>See paragraph 11.2.1 |

## 12. Diagnostics



### 12.1 Data Logging integrated in the board

The Ditec LCU40H control panel is equipped with an internal system that allows the installer to check whether any alarms have been triggered, how many times, and the log of the last twenty alarms.

#### 12.1.1 Alarm counter

With the third level menus enabled (**AT** → **AA**), go to **SF** → **AL** to see all the alarms recorded by the control panel. The display alternately shows the alarm code and the number of times it was triggered.

Example: **M0** \_ **05** \_ **M0** \_ **05** \_ ....

Use the  and  keys to scroll through the entire list of alarm counters.

#### 12.1.2 Alarm log

With the third level menus enabled (**AT** → **AA**), go to **SF** → **AH** to see the alarm log (the last 20 alarms recorded). The display shows the alarm number and code, alternated. The highest number corresponds to the most recent alarm and the lowest number corresponds to the oldest alarm.

Example: - **1** \_ **M0** \_ - **1** \_ **M0** \_ ....

Use  and  to scroll through the alarm log.

### 12.1.3 Exporting information on the microSD

With the third level menu enabled (**AT** → **AA**), the microSD card inserted and the automation idle, go to **SF** → **AE** to export all the control panel parameters to the microSD. The LCU40H\_INFO.txt text file created on the microSD contains all the alarm counters, the log showing the last twenty alarms, the operating statistics and the complete configuration of the control panel.

By inserting the microSD in a PC and opening the file LCU40H\_INFO.txt with the Ditec software, you can view all the control panel data.



**NOTE:** when the installation is complete, you are advised to delete the internal data logging.

### 12.2 Extended data logging on microSD

The Ditec LCU40H control panel can record every event and/or alarm for every operation performed.

To do this, you must leave a microSD inserted in the relative connector and then, with the third level menu enabled (**AT** → **AA**), set **SF** → **EJ** → **02**.

In this way, at the end of every operation the control panel will save all the events recorded up to that moment on the microSD (in the LCU40H.log file in the LCU40H\_LOG folder).

You can view all the recorded logs by inserting the microSD in a PC and opening the LCU40H.log file using the Ditec software.

This is an example of the visualisation of recorded events:

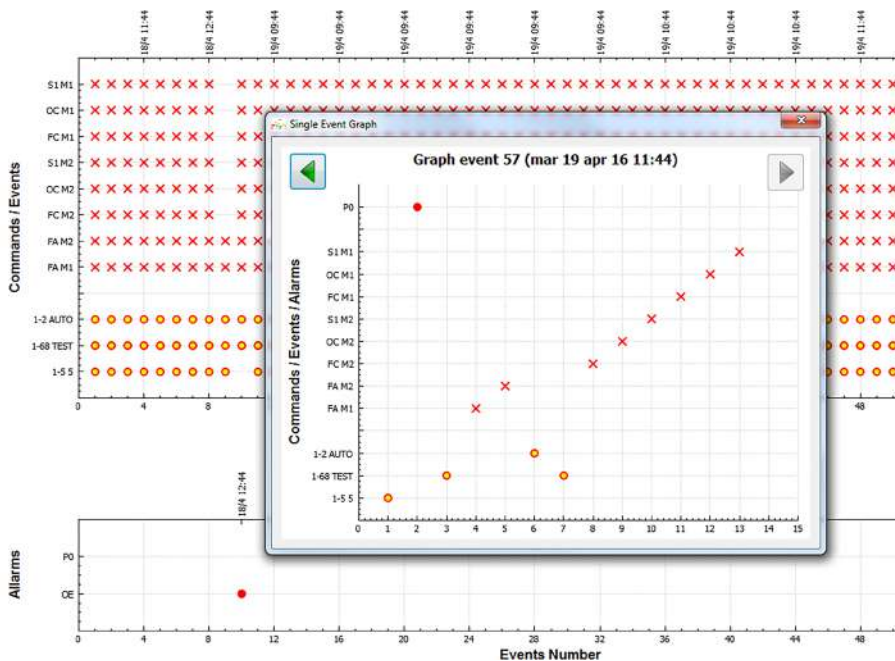

# 13. Signals visualised on the display

**i** **NOTE:** depending on the type of automation and control panel, certain visualisations may not be available.

## 13.1 Display of automation status

**i** **NOTE:** the automation status display mode is only visible with Display visualisation mode set to 02.

AP ▶ DS ▶ 02

| Display | Description                                 | Display | Description                              |
|---------|---------------------------------------------|---------|------------------------------------------|
|         | Automation closed                           |         | Automation opening                       |
|         | Automation open                             |         | Automation closing, from partial opening |
|         | Automation stopped in intermediate position |         | Automation in partial opening            |
|         | Automation closing                          |         | Automation partially open                |

## 13.2 Display of safety devices and commands

**i** **NOTE:** the safety device and command visualisation mode is only visible with Display visualisation mode set at 01 or 03.

AP ▶ DS ▶ 01

AP ▶ DS ▶ 03

| Display | Description                                | Display | Description                                                                    |
|---------|--------------------------------------------|---------|--------------------------------------------------------------------------------|
|         | 1-2 - Automatic closing activation command |         | 1-6 - Safety device with opening and closing stop                              |
|         | 1-3 - Opening command                      |         | 1-8 - Safety with closing reversal                                             |
|         | 1-4 - Closing command                      |         | 1-9 - STOP command                                                             |
|         | 1-5 - Step-by-step command                 |         | 68 - Selection of the device simultaneously connected to terminals 1-6 and 1-8 |

| Display | Description                                                                                                                                                                | Display | Description                                                          |
|---------|----------------------------------------------------------------------------------------------------------------------------------------------------------------------------|---------|----------------------------------------------------------------------|
| P3      | P3 - Partial opening command                                                                                                                                               | S2      | S2. - Detection of stop during opening - motor 1                     |
| 3P      | 3P - Opening command with operator present                                                                                                                                 | S.2     | S.2. - Detection of stop during opening - motor 2                    |
| 4P      | 4P - Closing command with operator present                                                                                                                                 | 00      | 00. - Reaching of obstacle detection limit during opening - motor 1  |
| RX      | RX - Radio reception (of any memorised key of a transmitter present in the memory)                                                                                         | 0.0     | 0.0. - Reaching of obstacle detection limit during opening - motor 2 |
| NX      | NX - Radio reception (of any non-memorised key)<br>NOTE: with the selection AP → JS → 0 1, it is also visualised when a command is received from a non-stored transmitter. | 0C      | 0C. - Reaching of obstacle detection limit during closing - motor 1  |
| EX      | EX - Rolling-code radio reception out of sequence                                                                                                                          | 0.C     | 0.C. - Reaching of obstacle detection limit during closing - motor 2 |
| EP      | EP - Radio reception not complying with the parameter configuration RO → EP                                                                                                | RV      | RV - Enabling/disabling of built-in radio receiver via RDX           |
| CX      | CX - Command received from AUX1 board                                                                                                                                      | MQ      | MQ - Learning operation of mechanical end stops in progress          |
| CY      | CY - Command received from AUX2 board                                                                                                                                      | HT      | HT - Heating of the motors (NIO function) in progress                |
| FC      | FC. - Closure limit switch - motor 1                                                                                                                                       | J1      | JR1 - Variation of the JR1 jumper status                             |
| F.C.    | F.C. - Closure limit switch - motor 2                                                                                                                                      | PC      | PC - Recognition of connected HOST (Personal Computer)               |
| FA      | FA. - Opening limit switch - motor 1                                                                                                                                       | ES      | ES - Switch to Green Mode (energy-saving)                            |
| F.A.    | F.A. - Opening limit switch - motor 2                                                                                                                                      | 1C      | 1C - Closing operation (1 gate wing at a time)                       |
| S1      | S1. - Detection of stop during closure - motor 1                                                                                                                           | SD      | SD - Recognition of microSD card                                     |
| S.1     | S.1. - Detection of stop during closure - motor 2                                                                                                                          | ED      | ED - Log storage on microSD                                          |

### 13.3 Visualisation of alarms and faults

**i** **WARNING:** the visualisation of alarms and faults is possible with any visualisation selection. The signalling of alarm messages takes priority over all other displays.

| Type of alarm    | Display        | Description                                                                       | Operation                                                                                                                                          |
|------------------|----------------|-----------------------------------------------------------------------------------|----------------------------------------------------------------------------------------------------------------------------------------------------|
| Mechanical alarm | M0             | M0 - Automation type not selected                                                 | Select a type of automation from the <b>AT</b> → <b>AS</b> menu                                                                                    |
|                  | M4             | M4 - Short circuit - motor 1                                                      | Check the connection of motor 1.<br>Check that the wing is not locked.<br>Check the operation of the electric lock                                 |
|                  | M5             | M5 - Short circuit - motor 2                                                      | Check the connection of motor 1.<br>Check that the wing is not locked.<br>Check the operation of the electric lock                                 |
|                  | MB             | MB - Absence of motor 1 during an operation                                       | Check the connection of motor 1.                                                                                                                   |
|                  | MC             | MC - Absence of motor 2 during an operation (if 2-motor functioning has been set) | Check the connection of motor 2.                                                                                                                   |
|                  | MD             | MD - Irregular functioning of motor 1 opening limit switch                        | Check the connection of the motor 1 opening limit switch.                                                                                          |
|                  | ME             | ME - Irregular functioning of motor 1 closing limit switch                        | Check the connection of the motor 1 closing limit switch.                                                                                          |
|                  | MF             | MF - Irregular functioning of motor 2 opening limit switch                        | Check the connection of the motor 2 opening limit switch.                                                                                          |
|                  | MG             | MG - Irregular functioning of motor 2 closing limit switch                        | Check the connection of the motor 2 closing limit switch.                                                                                          |
|                  | MH             | MH - Door wing overlap not correct                                                | Check that the motor which is the first to make the opening [M1] is connected as shown in fig. 1.                                                  |
|                  | MI             | MI - Detection of third consecutive obstacle                                      | Check for the presence of permanent obstacles along the stroke of the automation.                                                                  |
|                  | MX             | MX - Extra current detection during opening.                                      | Check for the presence of obstacles along the automation stroke.                                                                                   |
|                  | OD             | OD - Obstacle during opening - gate wing 1                                        | Check for the presence of obstacles along the automation stroke.                                                                                   |
|                  | OE             | OE - Obstacle during closure - gate wing 1                                        | Check for the presence of obstacles along the automation stroke.                                                                                   |
|                  | Settings alarm | OF                                                                                | OF - Obstacle during opening - gate wing 2                                                                                                         |
| OG               |                | OG - Obstacle during closure - gate wing 2                                        | Check for the presence of obstacles along the automation stroke.                                                                                   |
| Service alarm    | S6             | S6 - Incorrect setting of safety device test                                      | Check the configuration of parameters <b>DB, DB, GB</b> .<br>If <b>GB</b> → <b>S4</b> , <b>DB</b> and <b>DB</b> cannot be <b>P4</b> or <b>S4</b> . |
|                  | V0             | V0 - Request for maintenance intervention                                         | Proceed with the scheduled maintenance intervention.                                                                                               |

| Type of alarm                | Display | Description                                                                                                                                                                                                                                        | Operation                                                                                                              |
|------------------------------|---------|----------------------------------------------------------------------------------------------------------------------------------------------------------------------------------------------------------------------------------------------------|------------------------------------------------------------------------------------------------------------------------|
| Internal control panel alarm | I5      | I5 - No voltage 0-1 (faulty voltage regulator or short-circuit on accessories)                                                                                                                                                                     | Check there is no short-circuit in connection 0-1.<br>If the problem persists, replace the control panel.              |
|                              | I6      | I6 - Excessive voltage 0-1 (faulty voltage regulator)                                                                                                                                                                                              | Replace the control panel.                                                                                             |
|                              | I7      | I7 - Internal parameter error - value outside limits                                                                                                                                                                                               | Reset.<br>If the problem persists, replace the control panel.                                                          |
|                              | I8      | I8 - Program sequence error                                                                                                                                                                                                                        | Reset.<br>If the problem persists, replace the control panel.                                                          |
|                              | IA      | IA - Internal parameter error (EEPROM/FLASH)                                                                                                                                                                                                       | Reset.<br>If the problem persists, replace the control panel.                                                          |
|                              | IB      | IB - Internal parameter error (RAM)                                                                                                                                                                                                                | Reset.<br>If the problem persists, replace the control panel.                                                          |
|                              | IC      | IC - Operation time-out error (>5 min or >7 min in learning mode)                                                                                                                                                                                  | Manually check that the gate wing moves freely.<br>If the problem persists, replace the control panel.                 |
|                              | IE      | IE - Power supply circuit fault                                                                                                                                                                                                                    | Reset.<br>If the problem persists, replace the control panel.                                                          |
|                              | IM      | IM - MOSFET alarm - motor 1 in short-circuit or always ON                                                                                                                                                                                          | Reset.<br>Check the settings / operating of any limit switches.<br>If the problem persists, replace the control panel. |
|                              | IN      | IN - MOSFET alarm - motor 2 in short-circuit or always ON                                                                                                                                                                                          | Reset.<br>If the problem persists, replace the control panel.                                                          |
|                              | IO      | IO - Interrupted power circuit - motor 1 (motor MOSFET open or always OFF)                                                                                                                                                                         | Reset.<br>If the problem persists, replace the control panel.                                                          |
|                              | IP      | IP - Interrupted power circuit - motor 2 (motor MOSFET open or always OFF)                                                                                                                                                                         | Reset.<br>If the problem persists, replace the control panel.                                                          |
|                              | IS      | IS - Error on current read circuit test - motor 1                                                                                                                                                                                                  | Reset.<br>If the problem persists, replace the control panel.                                                          |
|                              | IT      | IT - Error on current read circuit test - motor 2                                                                                                                                                                                                  | Reset.<br>If the problem persists, replace the control panel.                                                          |
|                              | IU      | IU - Error on voltage read circuit test - motor 1                                                                                                                                                                                                  | Reset.<br>If the problem persists, replace the control panel.                                                          |
|                              | IV      | IV - Error on voltage read circuit test - motor 2                                                                                                                                                                                                  | Reset.<br>If the problem persists, replace the control panel.                                                          |
|                              | XX      | XX - Firmware reset commanded by the simultaneous pressing of the  +  keys. |                                                                                                                        |
|                              | WD      | WD - Firmware reset not commanded                                                                                                                                                                                                                  |                                                                                                                        |



| Type of alarm          | Display                                     | Description                                                                                                                                      | Operation                                                                                                                                          |
|------------------------|---------------------------------------------|--------------------------------------------------------------------------------------------------------------------------------------------------|----------------------------------------------------------------------------------------------------------------------------------------------------|
| Radio operations alarm | R0                                          | R0 - Insertion of a storage module containing over 100 stored remote controls<br><b>WARNING:</b> the R0 → MU → 20 setting is made automatically. | To save the system configurations on the storage module, delete any stored remote controls and bring the total to less than 100. Set R0 → MU → 10. |
|                        | R3                                          | R3 - Storage module not detected                                                                                                                 | Insert a storage module.                                                                                                                           |
|                        | R4                                          | R4 - Storage module not compatible with the control panel                                                                                        | Insert a compatible storage module.                                                                                                                |
|                        | R5                                          | R5 - No serial communication with the storage module                                                                                             | Replace the storage module.                                                                                                                        |
|                        | R6                                          | R6 - Insertion of a specific storage module for testing                                                                                          |                                                                                                                                                    |
| Power supply alarm     | P0                                          | P0 - No mains voltage                                                                                                                            | Check the control panel is powered correctly.<br>Check the line fuse.<br>Check the mains power supply.                                             |
|                        | P1                                          | P1 - Microswitch voltage too low                                                                                                                 | Check the control panel is powered correctly.                                                                                                      |
| Battery alarm          | B0                                          | B0 - Battery almost flat                                                                                                                         | Check battery voltage.<br>Replace battery.                                                                                                         |
| Accessories alarm      | A0                                          | A0 - Failure of test of safety sensor on contact 6                                                                                               | Check the device SOFA1-A2 is working correctly.<br>If the supplementary SOF board is not inserted, check the safety test is disabled.              |
|                        | A1                                          | A1 - Simultaneous safety sensor test on contacts 6 and 8 failed                                                                                  | Check the wiring and correct operation of the safety sensor.                                                                                       |
|                        | A3                                          | A3 - Failure of test of safety sensor on contact 8                                                                                               | Check the device SOFA1-A2 is working correctly.<br>If the supplementary SOF board is not inserted, check the safety test is disabled.              |
|                        | A7                                          | A7 - Incorrect connection of contact 9 to terminal 41                                                                                            | Check that terminal 1 and 9 are correctly connected.                                                                                               |
|                        | A9                                          | A9 - Overload on output +LP-                                                                                                                     | Check the device connected to output +LP- is working properly.                                                                                     |
|                        | AB                                          | AB - Overload on output 30-13                                                                                                                    | Check the device connected to output 30-13 is working properly.                                                                                    |
| AG                     | AG - Alarm for short-circuit on output -LK+ | Check the device connected to output -LK+ is working properly.                                                                                   |                                                                                                                                                    |

# 14. Troubleshooting

| Problem                                                                            | Possible cause                                                                                    | Alarm signalling                               | Operation                                                                                                                                                                                                                        |
|------------------------------------------------------------------------------------|---------------------------------------------------------------------------------------------------|------------------------------------------------|----------------------------------------------------------------------------------------------------------------------------------------------------------------------------------------------------------------------------------|
| The control panel does not switch on                                               | No power supply.                                                                                  |                                                | Check the power supply cable and the relative wiring                                                                                                                                                                             |
|                                                                                    | Overload on output 0-30                                                                           |                                                | Disconnect any loads connected to terminal 30                                                                                                                                                                                    |
| The automation does not open or close.                                             | No power.                                                                                         |                                                | Check power supply cable.                                                                                                                                                                                                        |
|                                                                                    | Short-circuited accessories                                                                       | <b>IS</b>                                      | Disconnect all accessories from terminals 0-30 (a voltage of 24V= must be present), then reconnect them one at a time.<br>Contact Technical Service                                                                              |
|                                                                                    | Blown line fuse.                                                                                  |                                                | Replace fuse.                                                                                                                                                                                                                    |
|                                                                                    | Safety contacts are open.                                                                         | <b>I-6 I-8</b><br><b>68</b>                    | Check that the safety contacts are closed correctly (NC).                                                                                                                                                                        |
|                                                                                    | Safety contacts not correctly connected or self-controlled safety edge not functioning correctly. | <b>A0 I-6</b><br><b>A1 I-8</b><br><b>A3 68</b> | Check connections to terminals 6-8 on control panel and connections to the self-controlled safety edge.                                                                                                                          |
|                                                                                    | Photocells activated.                                                                             | <b>I-6 I-8</b>                                 | Check that the photocells are clean and operating correctly.                                                                                                                                                                     |
|                                                                                    | The automatic closure does not work.                                                              |                                                | Issue any command. If the problem persists, contact Technical Service                                                                                                                                                            |
| The external safety devices are not activated.                                     | Incorrect connections between the photocells and the control panel.                               |                                                | Check that <b>I-6 / I-8</b> is displayed<br>Connect NC safety contacts together in series and remove any jumpers on the control panel terminal board.                                                                            |
|                                                                                    |                                                                                                   |                                                | Check the <b>AP → I6</b> and <b>AP → I8</b> setting                                                                                                                                                                              |
| The automation opens/closes briefly and then stops.                                | There is a presence of friction.                                                                  | <b>MI</b>                                      | Manually check that the automation moves freely and check the <b>R1/R2</b> adjustment.<br>Make sure that any limit switches, if present, are working correctly.<br>Contact Technical Service                                     |
| The remote control has limited range and does not work with the automation moving. | The radio transmission is impeded by metal structures and reinforced concrete walls.              |                                                | Install the antenna outside.                                                                                                                                                                                                     |
|                                                                                    |                                                                                                   |                                                | Replace the transmitter batteries.                                                                                                                                                                                               |
| The remote control does not work                                                   | No storage module or incorrect storage module.                                                    | <b>R0</b>                                      | Switch the automation off and plug in the correct storage module.                                                                                                                                                                |
|                                                                                    |                                                                                                   | <b>R3</b>                                      | Check the correct memorisation of the transmitters on the built-in radio. If there is a fault with the radio receiver that is built into the control panel, the remote control codes can be read by removing the storage module. |
|                                                                                    |                                                                                                   | <b>R5</b>                                      |                                                                                                                                                                                                                                  |

---

Ditec brand is owned by ASSA ABLOY. All the rights concerning this material are the exclusive property of ASSA ABLOY Entrance Systems AB. Although the contents of this publication have been drawn up with the greatest care, ASSA ABLOY Entrance Systems AB cannot be held responsible in any way for any damage caused by mistakes or omissions. We reserve the right to make changes without prior notice. Copying, scanning or changing in any way is expressly forbidden unless authorised in writing by ASSA ABLOY Entrance Systems AB.

 The crossed-out wheeled bin symbol indicates that the product should be disposed of separately from household waste. The product should be handed in for recycling in accordance with local environmental regulations for  waste disposal. By separating a marked item from household waste, you will help reduce the volume of waste sent to incinerators or landfill and minimize any potential negative impact on human health and the environment.

